

GURSAM

INTERNATIONAL



Chinese Bicycle, Parts



Index

	Pages
Hubs.....	4-12
Chainwheel & Crank.....	13-15
Derailleur	16-17
Chain Freewheel	18-19
Brake, Brake lever	20-24
BB Cartiridge	26-27
BB Cup, BB Set	28-31
Brake Wire	32-35
Handle Stem	36-37
Handle Bar	38-40
Seat Post, Bar Ends	41-42
Stands	43
Rims	44-46
Pedal	47-49
Saddle	50-53
Seat Clip	54
Pumps	55
Suspension Fork	56
Frame	57
Locks	58-59
Grips	60-62
Mudguards, Steel Balls.....	63
Lights	64
Helmets	65
Baskets, Brake Shoe.....	66
Hub Steps	67
Tyres, Tubes & Packing	68-71

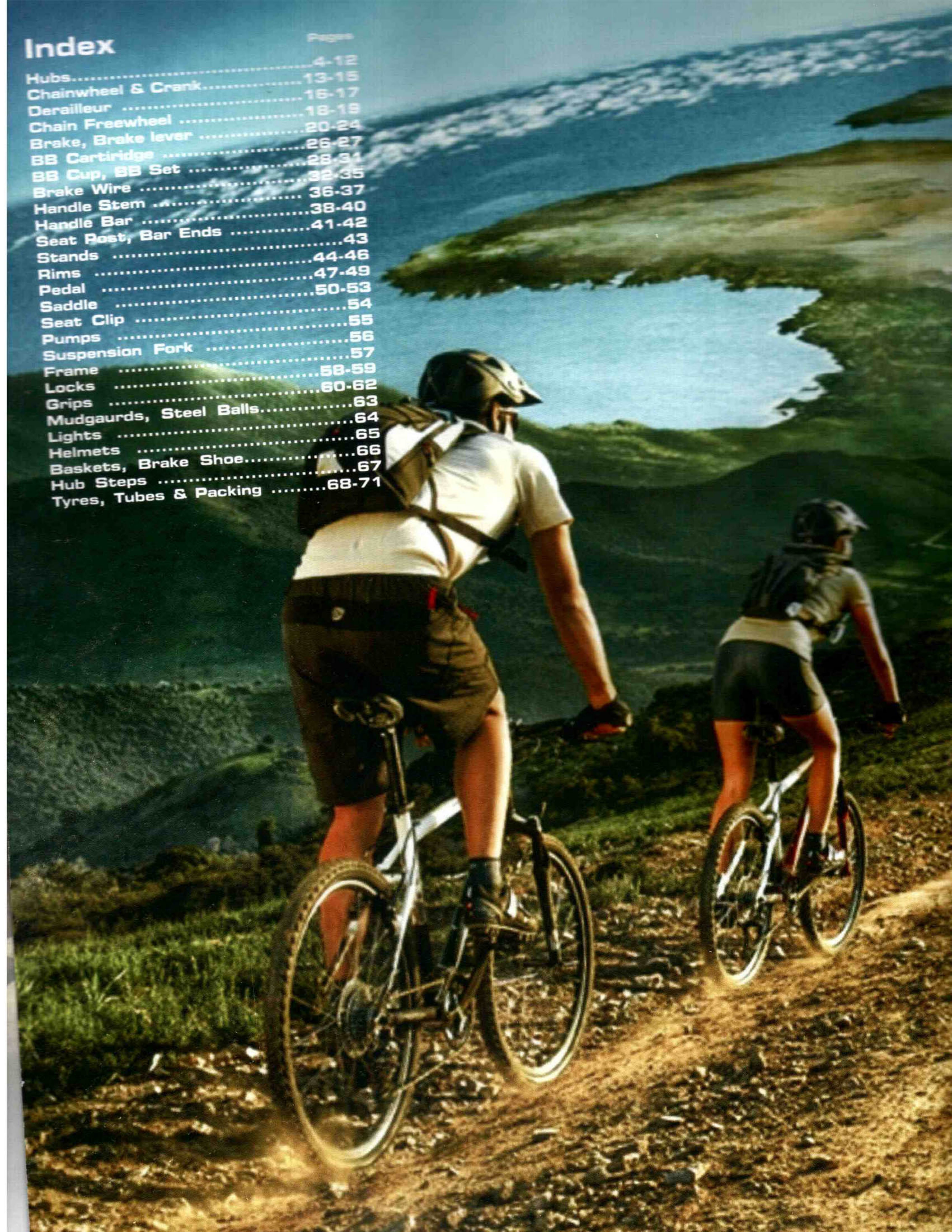

Company's Profile

Gursam International is an upcoming organization run under the leadership of Er. S.J. Singh & team of experienced & technically qualified professionals with a vast knowledge in engineering & non-engineering products.

Developing deep partnership with the leading manufacturing houses in India, Turkey, Thailand, China & Taiwan is the key to success, thereby meeting the customers specific needs, on-time delivery & substantial competitive prices. Assuring the right quality is another edge of this organization in meeting the customers uttermost satisfaction.

We have proven track record of exporting Bicycles, Bicycle Parts & Accessories, Hand Tools, Hardware Material, Fasteners, Hoists & EOT Cranes, Auto Parts, Auto Tyres & Tubes, Electric Lamps, & Luminaries, Electric Cables, Packaging Products, Granites Marbles & Ceramic Tiles, Sanitary Fitting, Gum Boots & Safety Boots, Confectionaries in markets of North America, Central America, Latin America, Caribbean, Middle East, Australia & West Africa. In our recent mile stone, our sister concern Veer Brothers Industrial Corporation has emerged as an export oriented Auto Parts manufacturing unit, meeting the changing needs of our customers worldwide.

Your valuable interaction for your needs will be highly appreciated.

Your Reliable & Trusted Partners

GURSAM INTERNATIONAL



Certificate

This is to certify that

Gursam International

B-29 1291 1, Street No. 7, Suraj Nagar, New Shimlapuri, Ludhiana - 141 003 (Punjab) India

has been assessed and certified by SGC as meeting the requirements of

ISO 9001 : 2008

Quality Management System

For the following activities:

Trading & Export of Bicycle Parts, Door & Cabinet Hinges for Industrial Application

Initial Date of Certification: Not Applicable Current Date of Certification: 09-April-2012

Date of Expiry: 08-April-2015

1. Surveillance Audit March 2013

2. Surveillance Audit March 2014

Certificate Number: QXIN/XXIV/75/011

ANZSIC Code: F-4539

JAS-ANZ



Director

SG Certifications Private Limited.

E-21, Sector-27, NOIDA - 201301 U.P. Ph: 120-4228788
www.sgcertifications.com email: info@sgcertifications.com



Registry information can be found at
www.jas-anz.com



GSHB-A01
STEEL HUB THIN TYPE
Spoke holes and dia as per order.
Finish : CP or ED



GSHB-A03
STEEL HUB PARALAX TYPE
Spoke holes and dia as per order.
Finish : CP or ED



GSHB-A05
STEEL HUB OVAL TYPE
Spoke holes and dia as per order.
Finish : CP or ED



HUBS



GSHB-A06
STEEL HUB
Spoke holes and dia as per order.
Finish : CP or ED

GSHB-A08
STEEL HUB PARALAX TYPE
With Quick Release
Spoke holes and dia as per order.
Finish : CP or ED

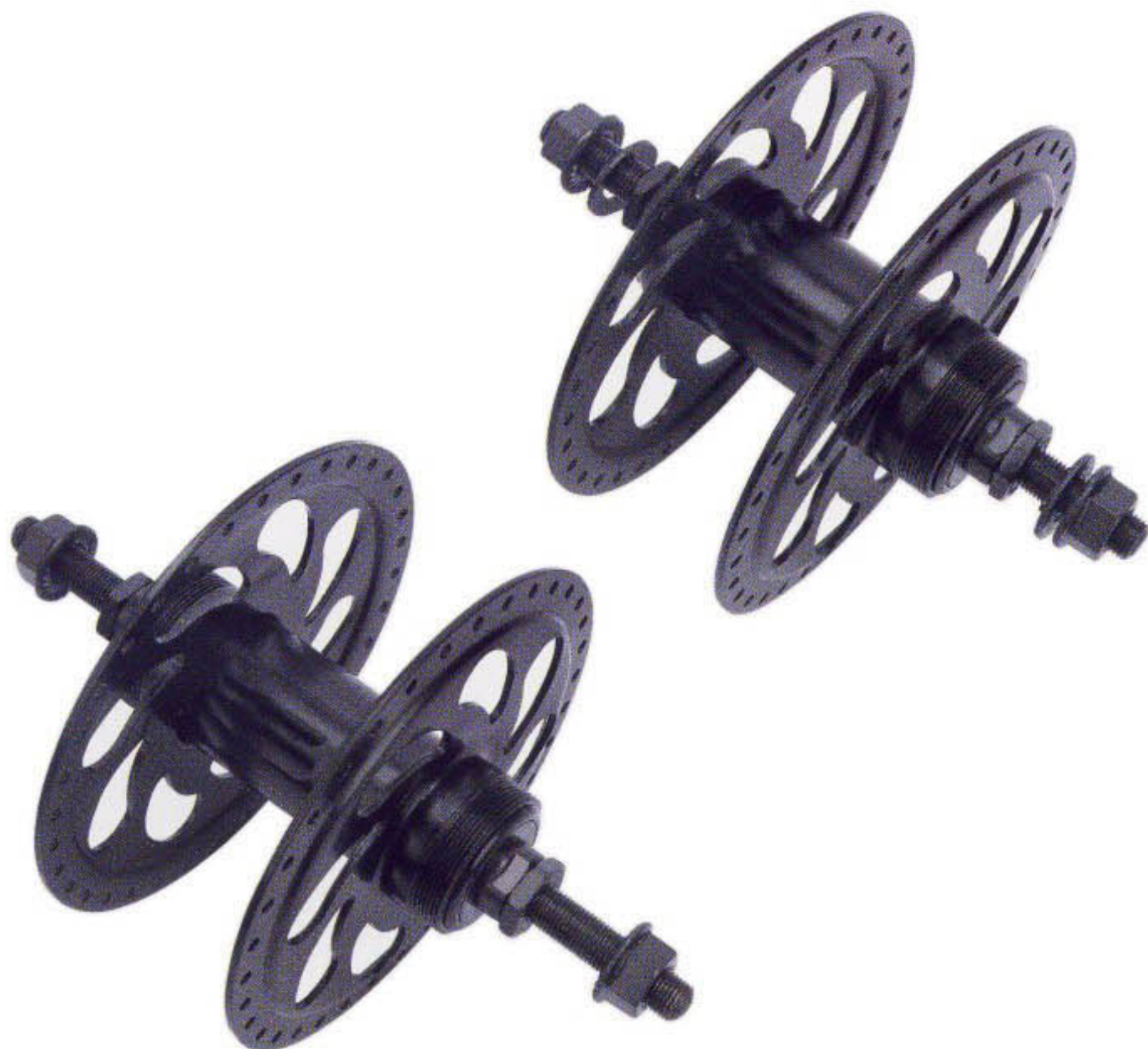

GSHB-A21
STEEL HUB FREESTYLE
Spokes Holes 36H/48H/68H
Spoke Dia 2mm
Finish : ED





GSHB-A23
STEEL HUB HEAVY DUTY
Spoke Holes 36H/48H/68H/140H
Spoke Dia 2mm
Finish : CP or ED

GSHB-A29
STEEL HUB OVAL TYPE
With Steel Bearings
Spoke holes & dia as per order
Finish : CP or ED



GSHB-A32
STEEL HUB PARALAX TYPE
With Steel Bearings
Spoke holes & dia as per order
Finish : CP or ED

HUBS



GSHB-A38
WHEEL CHAIR HUB STEEL
Axle 1/2"
Spoke holes to order
Finish : CP or ED



GSHB-A39
WHEEL CHAIR HUB STEEL
Axle 1/2"
Spoke holes to order
Finish : CP or ED



GSHB-A46
ELEPHANT HUB MEXICO TYPE
Spoke hole and diameter as per order
Axle 1/2, 12G, 36H, Axle - 160mm
Finish : CP or ED





GAHB-B02
ALLOY HUB PARALAX TYPE
Spoke holes and dia as per order
Finish : Silver or colored

GAHB-B03
ALLOY HUB PARALAX TYPE
with Quick Release
Spoke holes and dia as per order.
Finish : Silver or colored



GAHB-B05
ALLOY HUB OVAL TYPE
Spoke hole and diameter as per order
Finish : Silver or colored

HUBS



GAHB-B07
ALLOY HUB
For Disc Brake with quick release
Finish : Silver or colored



GAHB-B12
ALLOY HUB PARALAX TYPE
Suitable for Disc Brake and
cassette freewheel
Finish : Silver or colored



GAHB-B13
ALLOY HUB
With quick release with sealed bearings
Finish : Silver or colored

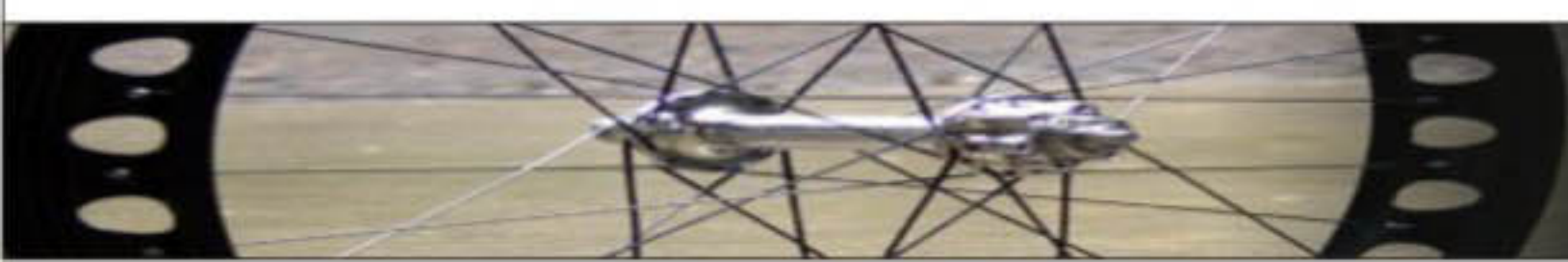

HUBS



GAHB-A222F
ALLOY HUB FRONT
 Alloy hub front with sealed bearing
 PCD 45mm
 Finish : Silver or colored



GAHB-A222R
ALLOY HUB REAR
 With sealed bearings
 PCD 45mm
 Finish : Silver or colored



GHAX-AX01
HUB AXLE WITH DUST CAPS
 Finish : UPC or BLACK



GHAX-AX05
HUB AXLE
 With Sealed Bearing
 Finish : UPC, NP or BLACK



GDL-404M



GDL-400M

GDL-404M
 5/16" x 130mm
 Packing : 30 Doz/ctn
 N.W/G.W : 25/26kgs
 Meas : 32x25x22cm

GDL-400M
 3/8" x 140mm
 Packing : 20 Doz/ctn
 N.W/G.W : 31/32kgs
 Meas : 33x28x24cm



GDL-404S



GDL-400S

GDL-404S
 5/16" x 130mm
 Packing : 30 Doz/ctn
 N.W/G.W : 25/26kgs
 Meas : 32x25x22cm

GDL-400S
 3/8" x 140mm
 Packing : 20 Doz/ctn
 N.W/G.W : 31/32kgs
 Meas : 33x28x24cm



GDL-403A



GDL-403B



GDL-403K

GDL-403A 3/8" x 175mm Packing : 20 Doz/ctn N.W/G.W : 35/36kgs Meas : 38x25x21cm	GDL-403B 3/8" x 175mm Packing : 20 Doz/ctn N.W/G.W : 37/38kgs Meas : 38x25x21cm	GDL-403K 3/8" x 175mm Packing : 20 Doz/ctn N.W/G.W : 38/39kgs Meas : 39x28x24cm
--	--	--



GDL-403



GDL-403E



GDL-403T

GDL-403 3/8" x 175mm Packing : 20 Doz/ctn N.W/G.W : 35/36kgs Meas : 38x25x21cm	GDL-403E 3/8" x 175mm Packing : 20 Doz/ctn N.W/G.W : 37/38kgs Meas : 38x25x21cm	GDL-403T 3/8" x 175mm Packing : 20 Doz/ctn N.W/G.W : 38/39kgs Meas : 39x28x24cm
---	--	--



HUBS

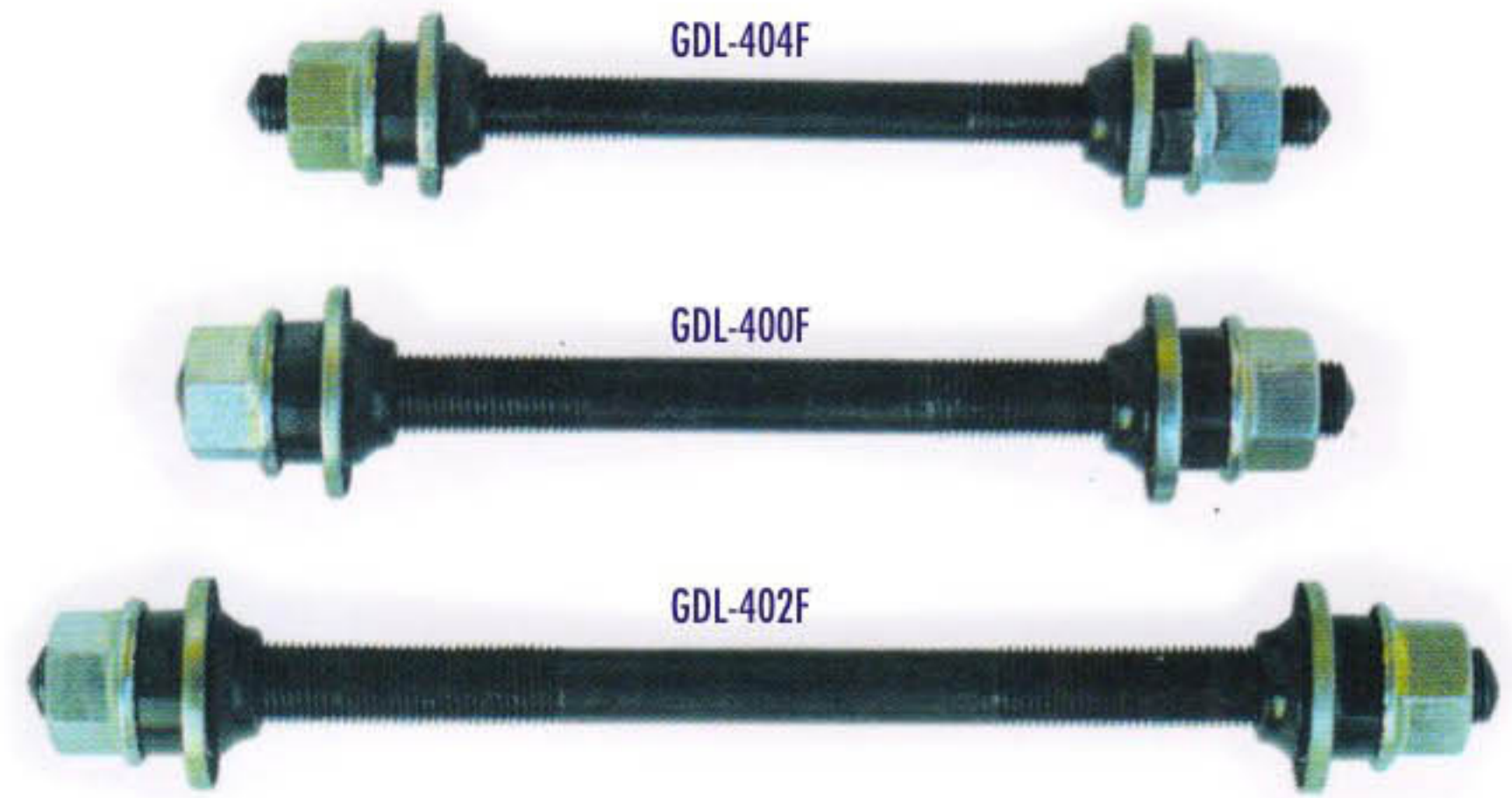

GDL-404F 5/16" x 130mm Packing : 30Doz/ctn N.W/G.W : 22/23kgs Meas : 32x25x22cm	GDL-400F 3/8" x 140mm Packing : 20 Doz/ctn N.W/G.W : 30/31kgs Meas : 33x28x34cm	GDL-402F 3/8" x 170mm Packing : 20 Doz/ctn N.W/G.W : 33/34kgs Meas : 39x28x24cm
--	--	--



GDL-404H 5/16" x 130mm Packing : 30Doz/ctn N.W/G.W : 22/23kgs Meas : 32x25x22cm	GDL-400H 3/8" x 140mm Packing : 20 Doz/ctn N.W/G.W : 30/31kgs Meas : 33x28x34cm	GDL-402H 3/8" x 170mm Packing : 20 Doz/ctn N.W/G.W : 33/34kgs Meas : 39x28x24cm
--	--	--



GDL-404K 5/16" x 130mm Packing : 30Doz/ctn N.W/G.W : 24/25kgs Meas : 32x25x22cm	GDL-400K 3/8" x 140mm Packing : 20 Doz/ctn N.W/G.W : 33/34kgs Meas : 33x28x24cm	GDL-402K 3/8" x 170mm Packing : 20 Doz/ctn N.W/G.W : 33/37kgs Meas : 39x28x24cm
--	--	--

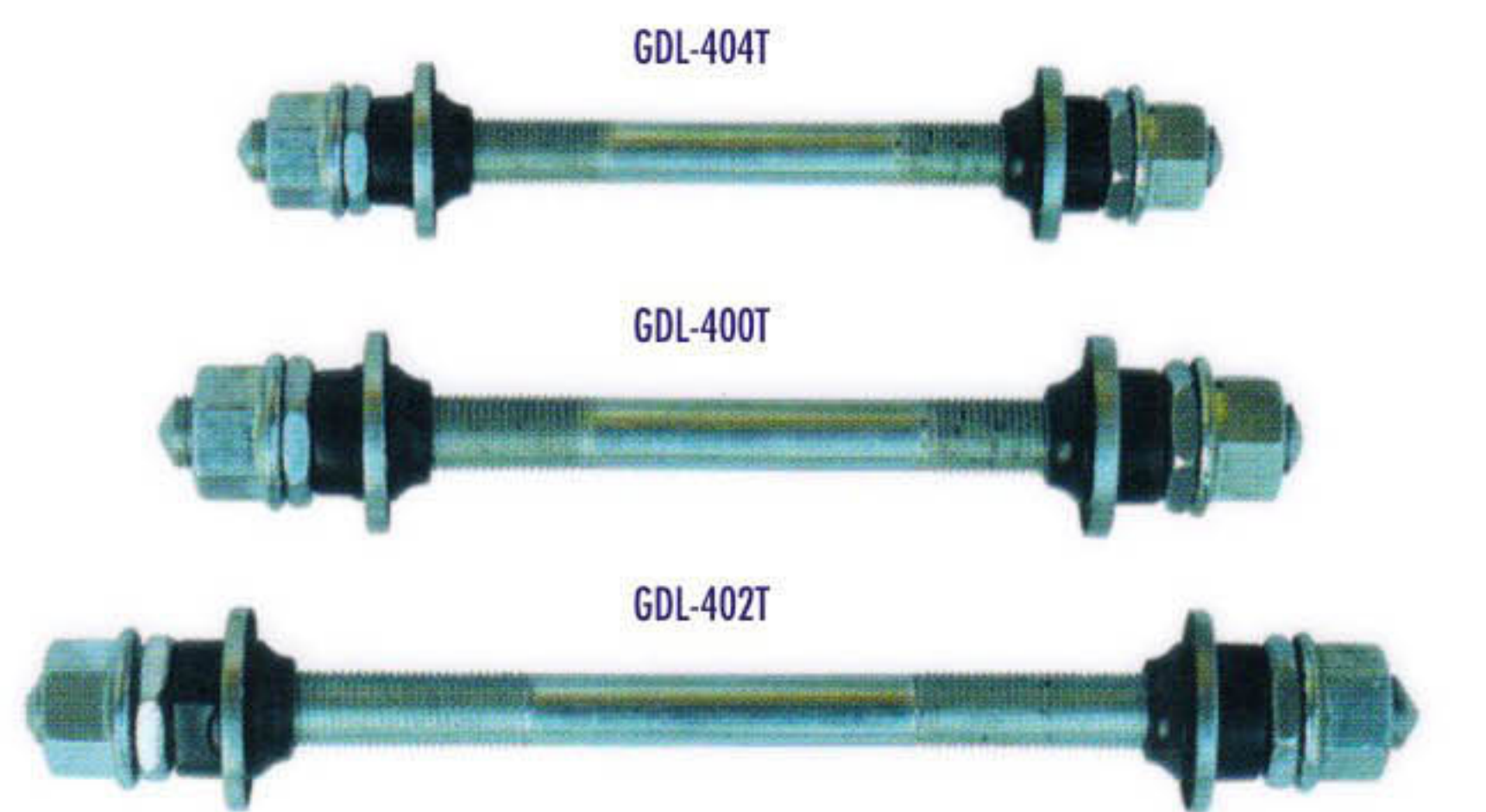

GDL-404T 5/16" x 130mm Packing : 30Doz/ctn N.W/G.W : 24/25kgs Meas : 32x25x22cm	GDL-400T 3/8" x 140mm Packing : 20 Doz/ctn N.W/G.W : 33/34kgs Meas : 33x28x24cm	GDL-402T 3/8" x 170mm Packing : 20 Doz/ctn N.W/G.W : 33/34kgs Meas : 39x28x24cm
--	--	--

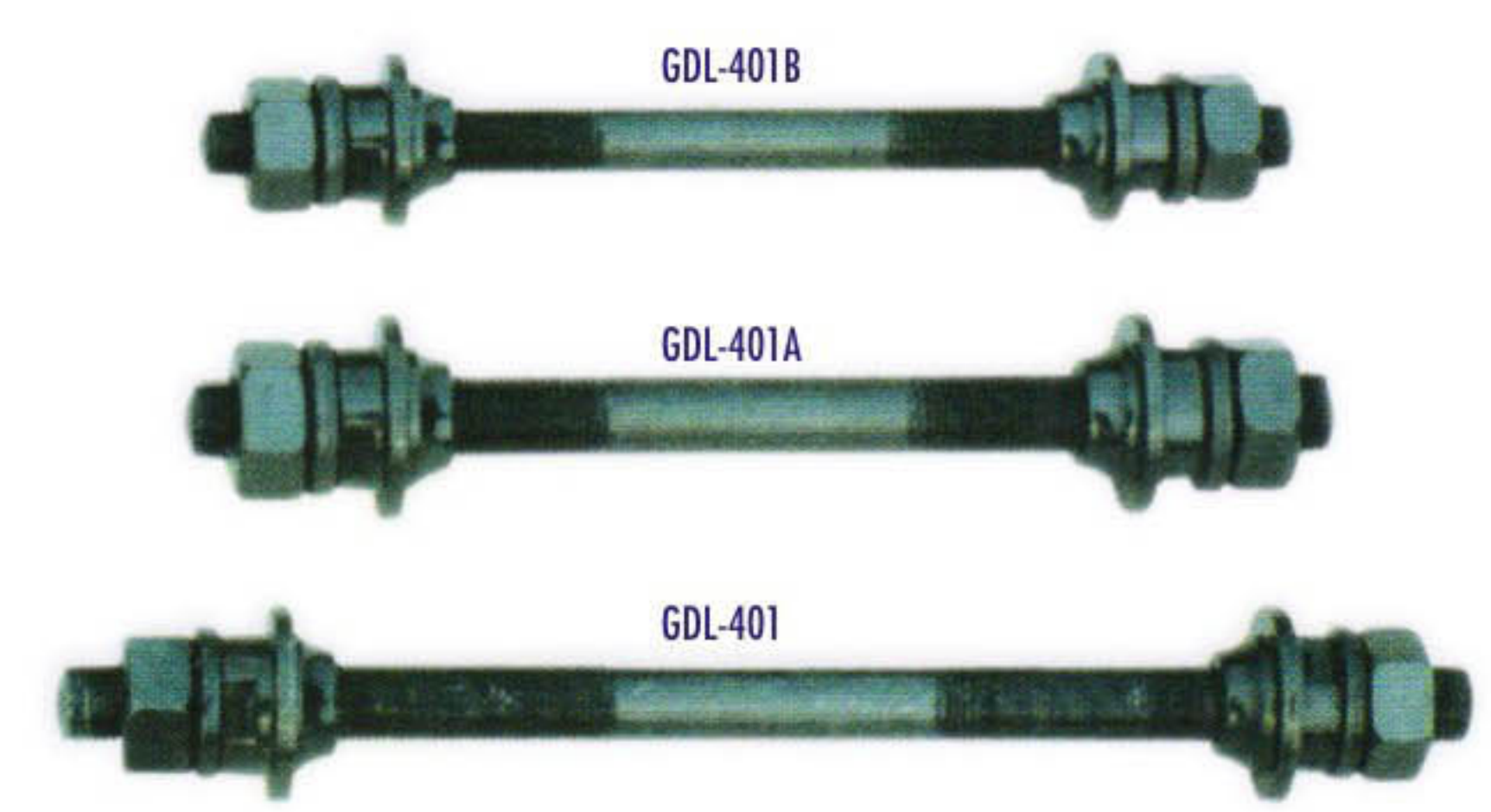

GDL-401B 5/16" x 130mm Packing : 20Doz/ctn N.W/G.W : 22/23kgs Meas : 32x25x22cm	GDL-401A 3/8" x 140mm Packing : 20 Doz/ctn N.W/G.W : 31/32 kgs Meas : 33x28x24cm	GDL-401 3/8" x 175mm Packing : 20 Doz/ctn N.W/G.W : 34/35kgs Meas : 39x28x24cm
--	---	---

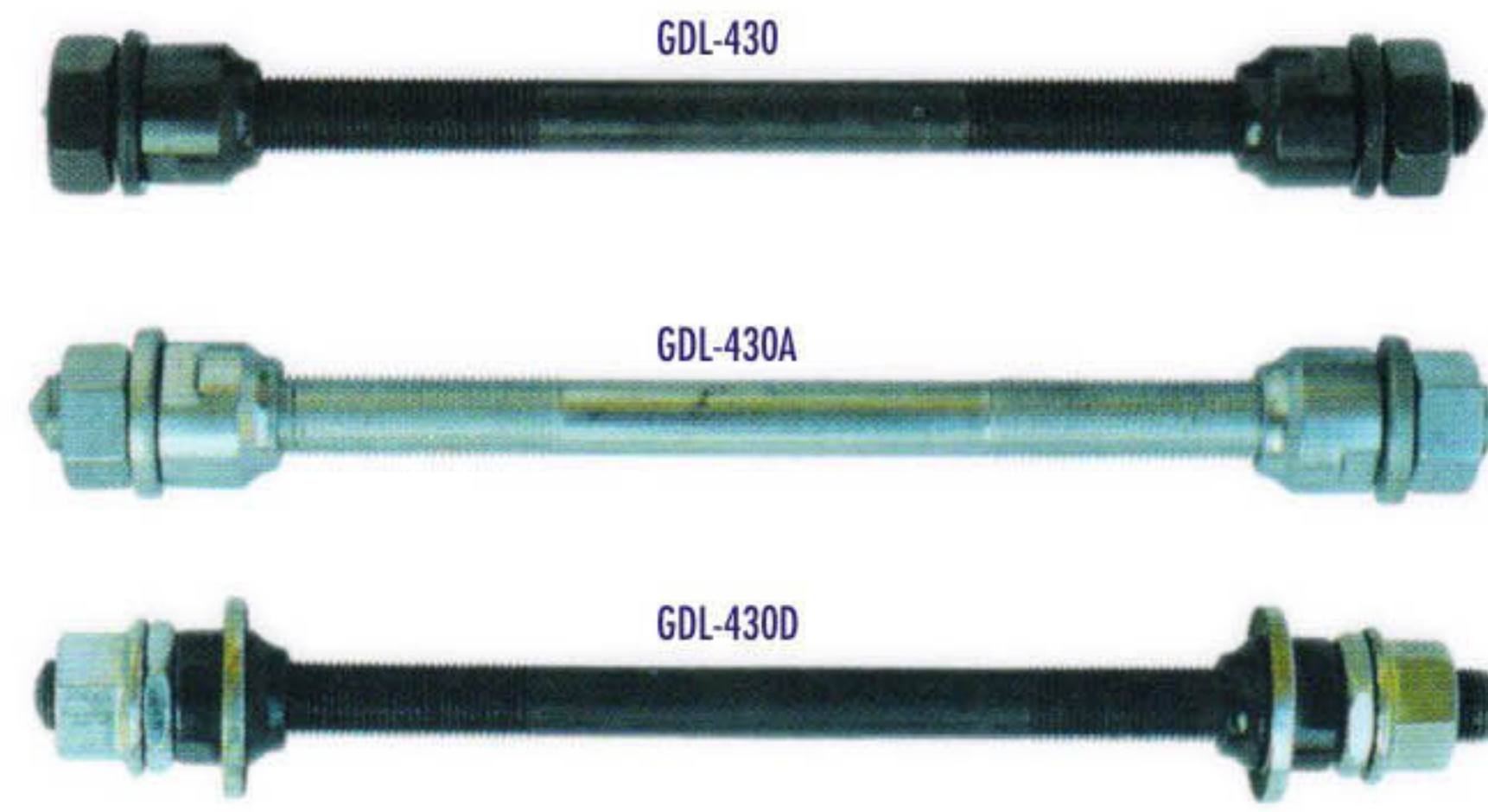

GDL-430 3/8" x 190mm Packing : 20 Doz/ctn N.W/G.W : 35/36kgs Meas : 42x25x21cm	GDL-430A 3/8" x 190mm Packing : 20 Doz/ctn N.W/G.W : 35/36kgs Meas : 42x25x21cm	GDL-430D 3/8" x 190mm Packing : 20 Doz/ctn N.W/G.W : 38/39kgs Meas : 42x25x21cm
---	--	--





GDL-404 5/16" x 130mm Packing : 30Doz/ctn N.W/G.W : 28/29kgs Meas : 32x25x21cm	GDL-400 3/8"x 140mm Packing : 20 Doz/ctn N.W/G.W : 29/30kgs Meas : 32x25x21cm	GDL-402 3/8"x 170mm Packing : 20 Doz/ctn N.W/G.W : 32/33kgs Meas : 38x25x21cm
---	--	--

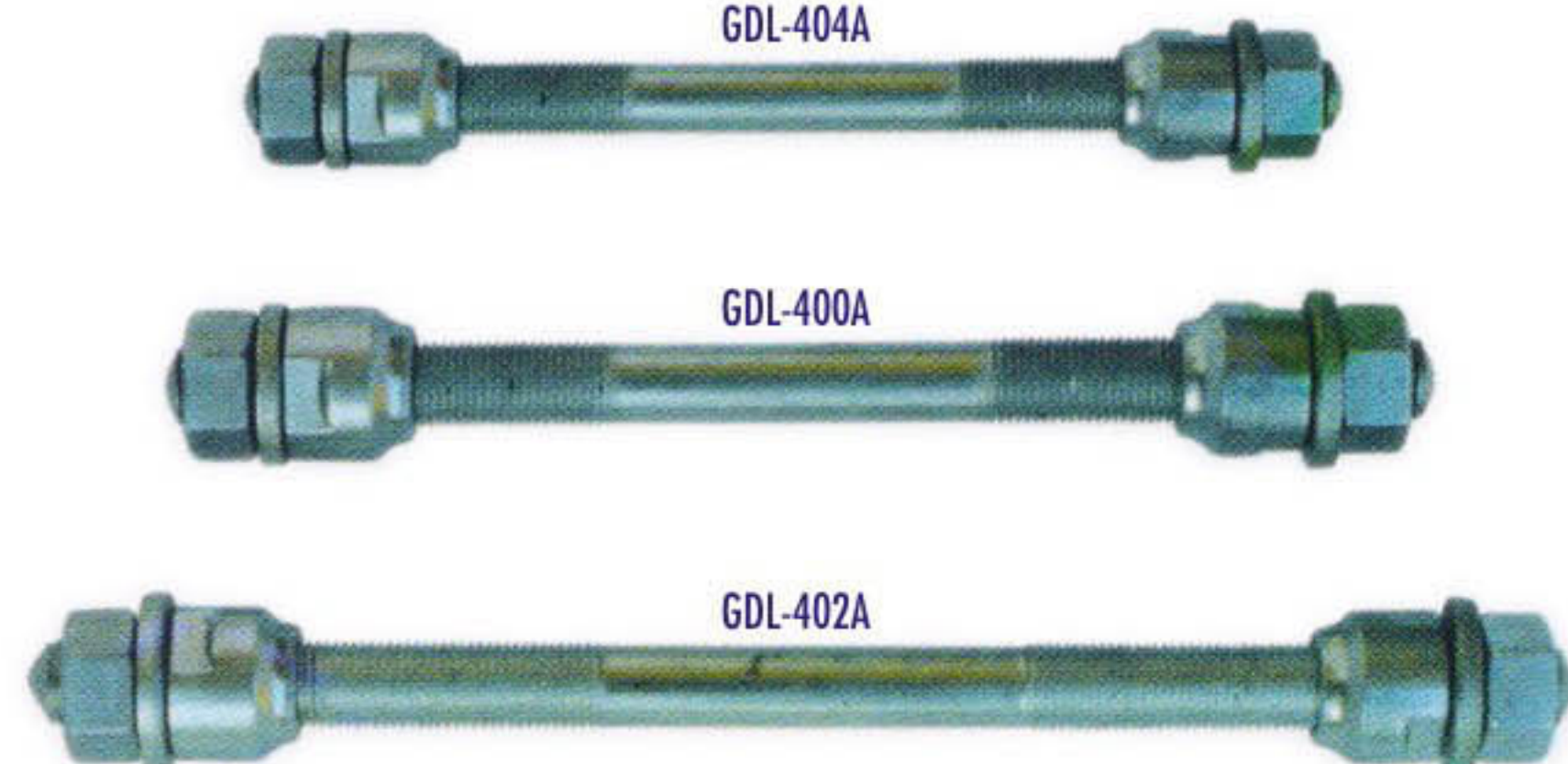

GDL-404A 5/16" x 130mm Packing : 30Doz/ctn N.W/G.W : 28/29kgs Meas : 32x25x21cm	GDL-400A 3/8"x 140mm Packing : 20 Doz/ctn N.W/G.W : 29/30kgs Meas : 32x25x21cm	GDL-402A 3/8"x 170mm Packing : 20 Doz/ctn N.W/G.W : 32/33kgs Meas : 38x25x21cm
--	---	---



GDL-404B 5/16" x 130mm Packing : 30Doz/ctn N.W/G.W : 29/30kgs Meas : 32x25x21cm	GDL-400B 3/8"x 140mm Packing : 20 Doz/ctn N.W/G.W : 29/30kgs Meas : 32x25x21cm	GDL-402B 3/8"x 170mm Packing : 20 Doz/ctn N.W/G.W : 32/33kgs Meas : 38x25x21cm
--	---	---

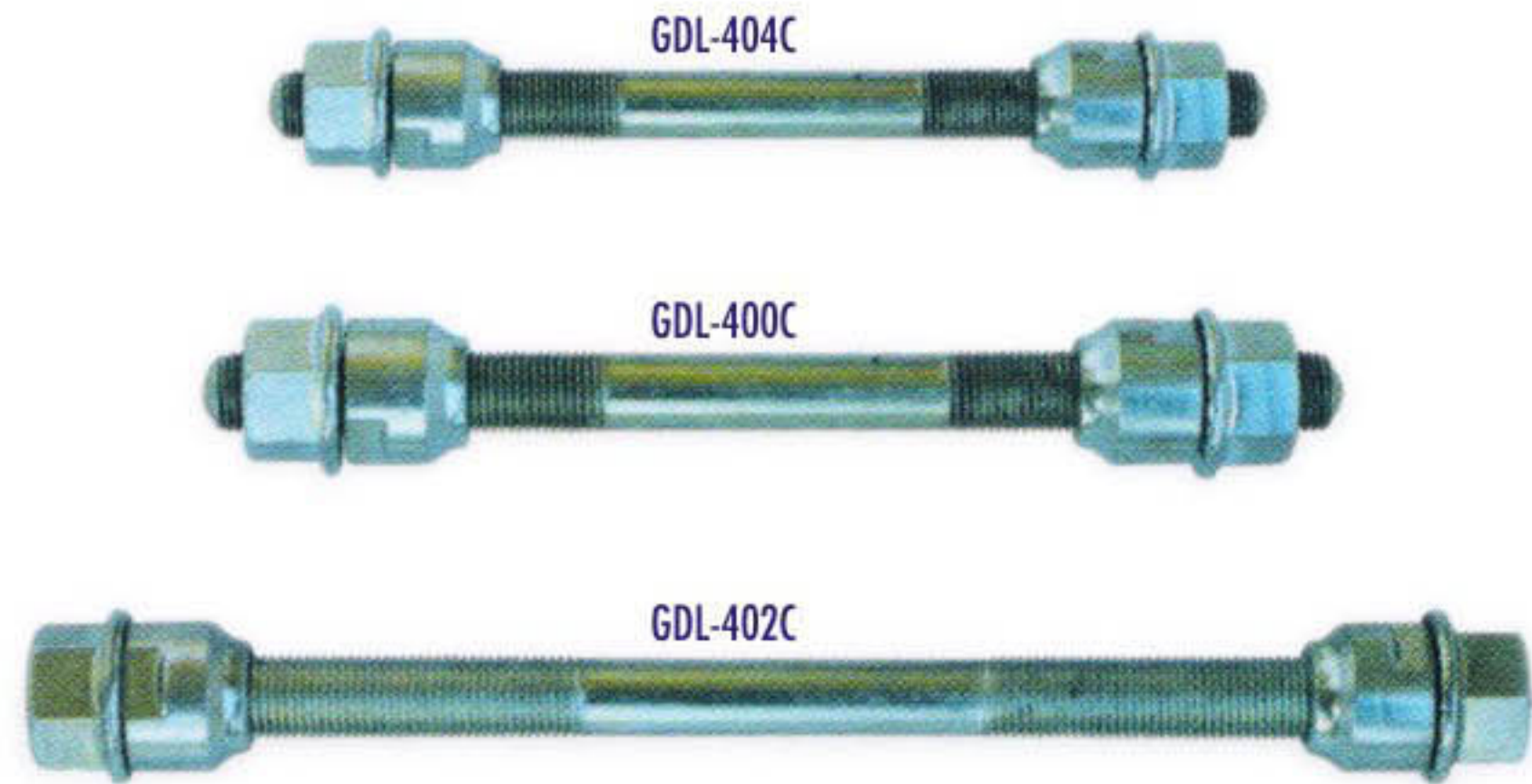

GDL-404C 5/16" x 130mm Packing : 30Doz/ctn N.W/G.W : 29/30kgs Meas : 32x25x21cm	GDL-400C 3/8"x 140mm Packing : 20 Doz/ctn N.W/G.W : 29/30kgs Meas : 32x25x21cm	GDL-402C 3/8"x 170mm Packing : 20 Doz/ctn N.W/G.W : 32/33kgs Meas : 38x25x21cm
--	---	---



GDL-404D 5/16" x 130mm Packing : 30Doz/ctn N.W/G.W : 32/33kgs Meas : 32x25x21cm	GDL-400D 3/8"x 140mm Packing : 20 Doz/ctn N.W/G.W : 32/33kgs Meas : 32x25x21cm	GDL-402D 3/8"x 170mm Packing : 20 Doz/ctn N.W/G.W : 34/35kgs Meas : 38x25x21cm
--	---	---

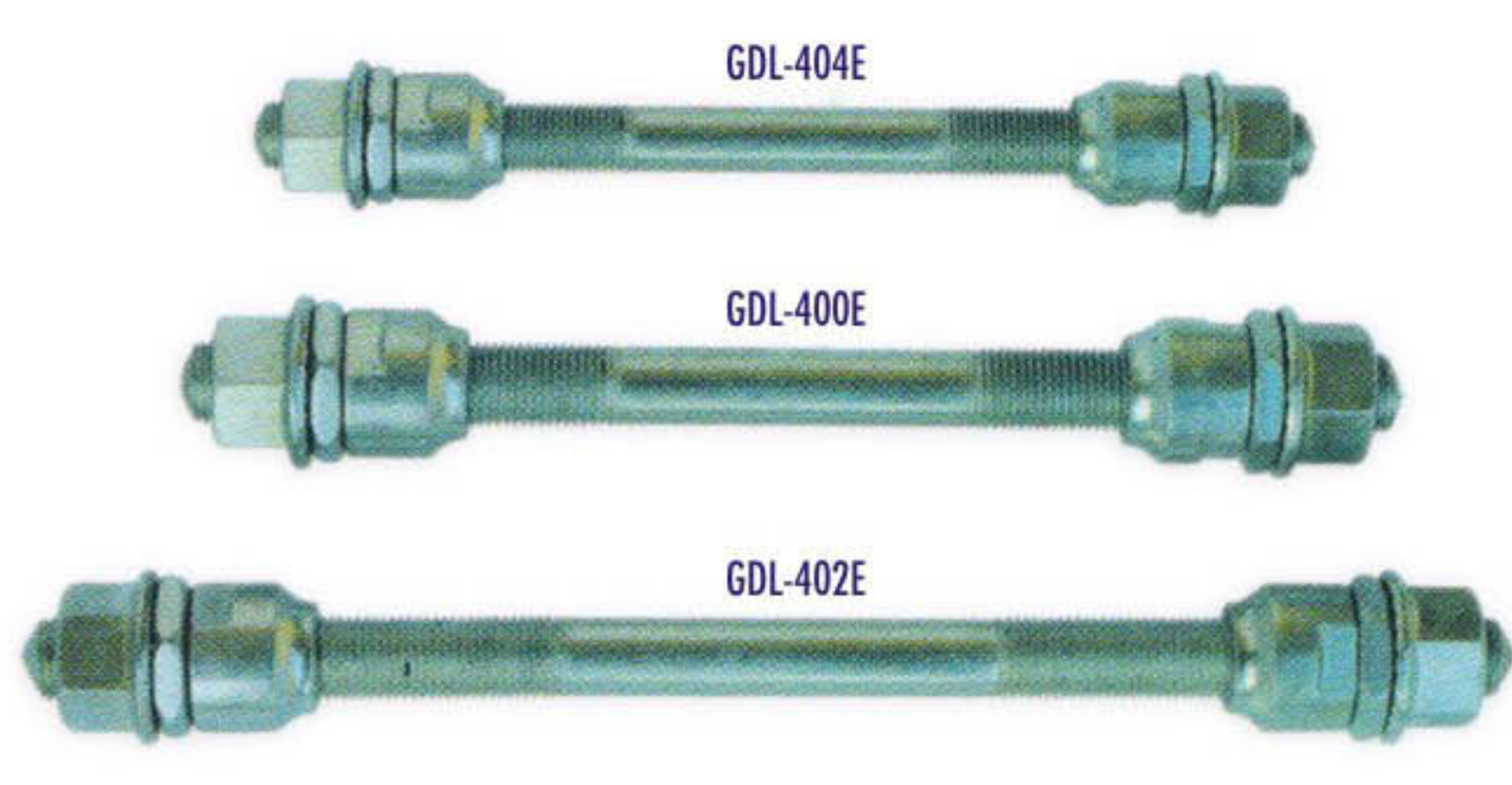

GDL-404E 5/16" x 130mm Packing : 30Doz/ctn N.W/G.W : 32/33kgs Meas : 32x25x21cm	GDL-400E 3/8"x 140mm Packing : 20 Doz/ctn N.W/G.W : 32/33kgs Meas : 32x25x21cm	GDL-402E 3/8"x 170mm Packing : 20 Doz/ctn N.W/G.W : 34/35kgs Meas : 38x25x21cm
--	---	---

CHAINWHEEL



GTCW-P317
TRIPLE CHAINWHEEL
with plastified crank
Finish : To Order



GTCW-P303
TRIPLE CHAINWHEEL
with plastified crank
Finish : To Order



GTCW-P310
TRIPLE CHAINWHEEL
with plastified crank
Finish : To Order



GTCW-P302
TRIPLE CHAINWHEEL
with plastified crank
Finish : To Order



GTCW-P306
TRIPLE CHAINWHEEL
with plastified crank
Finish : To Order



GTCW-P338
TRIPLE CHAINWHEEL
with plastified crank
Finish : To Order



GTCW-S306
TRIPLE CHAINWHEEL
with steel Crank
Finish : To Order



GTCW-A303
TRIPLE CHAINWHEEL
with alloy crank
Finish : To Order



GTCW-A316
TRIPLE CHAINWHEEL
with alloy crank
Finish : To Order



GSCW-P102
CHAINWHEEL
with Plastified Crank
Teeth : 48T, Finish : To Order



GSCW-P107
CHAINWHEEL
with Plastified Crank
Teeth : 40T, Finish : To Order



GSCW-P101
CHAINWHEEL
with Plastified Crank
Teeth : 44T, Finish : To Order



CHAINWHEEL

CURSAM



GSCW-S149
CHAINWHEEL & CRANK STEEL
 Italian Type. Cottered/ Cotterless
 Size : 28/36/40/44/48/52
 Finish : CP or ED



GSCW-S150
CHAINWHEEL & CRANK STEEL
 Olympic design. Cottered/ Cotterless
 Size : 28/36/40/44/48/52
 Finish : CP or ED



GSCW-S151
CHAINWHEEL & CRANK STEEL
 Japan Type. Cottered/ Cotterless
 Size : 44/46/48
 Finish : CP or ED



GSCW-S152
CHAINWHEEL & CRANK STEEL
 with 6 circles. Cottered/ Cotterless
 Size : 28/36/40/44/48/52
 Finish : To Order



GOPCW-Z101
CHAINWHEEL FOR OPC
 No. of Teeth : 28/32/36/40/44/46T
 Finish : CP or ED

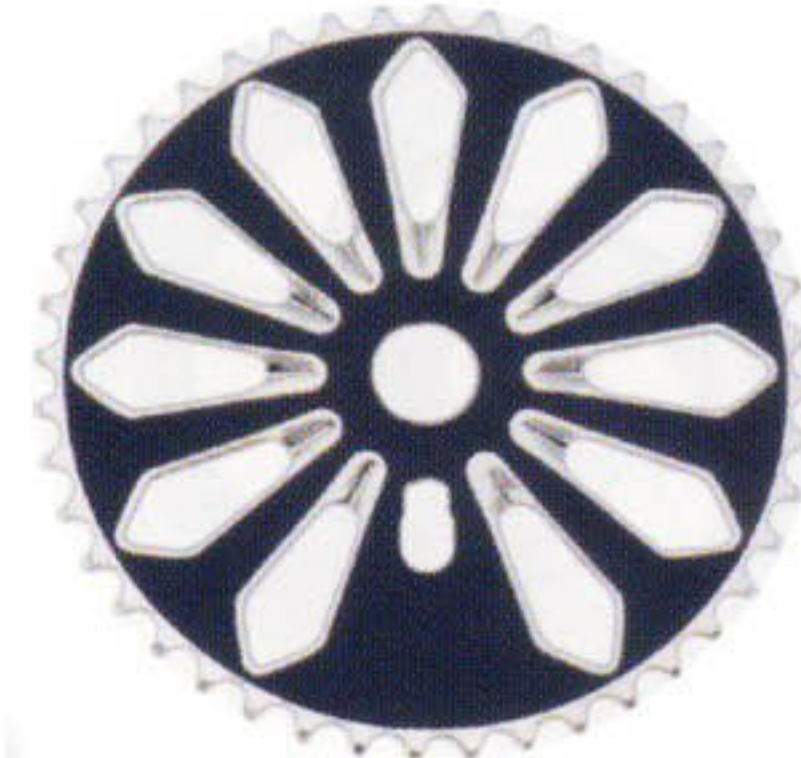

GOPCW-Z116
CHAINWHEEL FOR OPC
 No. of Teeth : 44/46T
 Finish : na



GOPCW-Z117
CHAINWHEEL FOR OPC
 No. of Teeth : 44/46T
 Finish : na



GOPCW-Z136
CHAINWHEEL FOR OPC
 No. of Teeth : 36/40/44T/46T
 Finish : CP or ED



GOPCW-Z137
CHAINWHEEL FOR OPC
 No. of Teeth : 40/44T/46T/52T
 Finish : CP or ED



GOPCW-Z138
CHAINWHEEL FOR OPC
 No. of Teeth : 46T
 Finish : CP or ED



GOPCW-Z139
CHAINWHEEL FOR OPC
 No. of Teeth : 40/44T/46T
 Finish : CP or ED



GOPCW-Z141
CHAINWHEEL FOR OPC
 No. of Teeth : 32/36T
 Finish : CP or ED

CHAINWHEEL



GOPCW-Z306
TRIPLE CHAINWHEEL FOR OPC
No. of Teeth : 28/38/48T Index
Finish : CP or ED



GLC-P08
LEFT CRANK PLASTIFIED
Length to order.
Finish : BED or GRIS



GLC-S12
LEFT CRANK STEEL
Cottered or Cotterless
Finish : CP or ED



GOPC-Z001
CRANK AMERICAN TYPE BNCP ONE PIECE
Dia 15mm/16mm. Length to choose
Finish : To Order



GOPC-Z004
CRANK SWEDISH TYPE BNCP ONE PIECE
Dia 15mm/16mm. Length to choose
Finish : To Order



DERAILLEUR

GURSAM



GFD-XC-02
FRONT DERAILLEUR FRICTION
Top Pull or Down Pull,
Clamp Dia : 28.6mm/ 31.8mm
Gear Capacity: 22T - 48T
Finish : CP, UCP or ED



GFD-XC-04
FRONT DERAILLEUR INDEX
Suitable for both Top Pull & Down Pull,
Clamp Dia : 28.6mm/ 31.8mm
Finish : CP, UCP or ED



GRD-XC-03
REAR DERAILLEUR FRICTION
Long Cage With Bracket. Capacity 36T
Finish : CP, UCP or ED



GRD-XC-04
REAR DERAILLEUR FRICTION
Long Cage Without Bracket. Capacity 36T
Finish : CP, UCP or ED



GRD-XC-01
REAR DERAILLEUR FRICTION
Short Cage With Bracket
Finish : CP, UCP or ED



GRD-XC-40
REAR DERAILLEUR INDEX
Long Cage Megarage with Bracket. Capacity 36T
Finish : CP, UCP or ED

DERAILLEUR & SHIFTER



GRD-XC-40A
REAR DERAILLEUR INDEX
 Long Cage Megarage without Bracket. Capacity 36T
 Finish : CP, UCP or ED



GSL-XC-01
THUMB SHIFTING LEVER NYLON
 Steel Clamp dia 22.2mm
 Finish : na



GGs-XC-01
GRIP SHIFTER NYLON NON INDEX
 Clamp dia 22.2mm
 Finish : na



GSL-XC-03
THUMB SHIFTING LEVER ALLOY
 With Resin, Steel Clamp Dia 22.2mm
 Finish : na



GTS-SM-02
TWIST DUAL INDEX SHIFTER
 with Brake Lever alloy, Clamp dia 22.2mm
 18/21/24 spd



GGs-XC-3S/7S-R
21 SPEED DUAL INDEX GRIP SHIFTER
 Clamp dia 22.2mm
 Finish : na

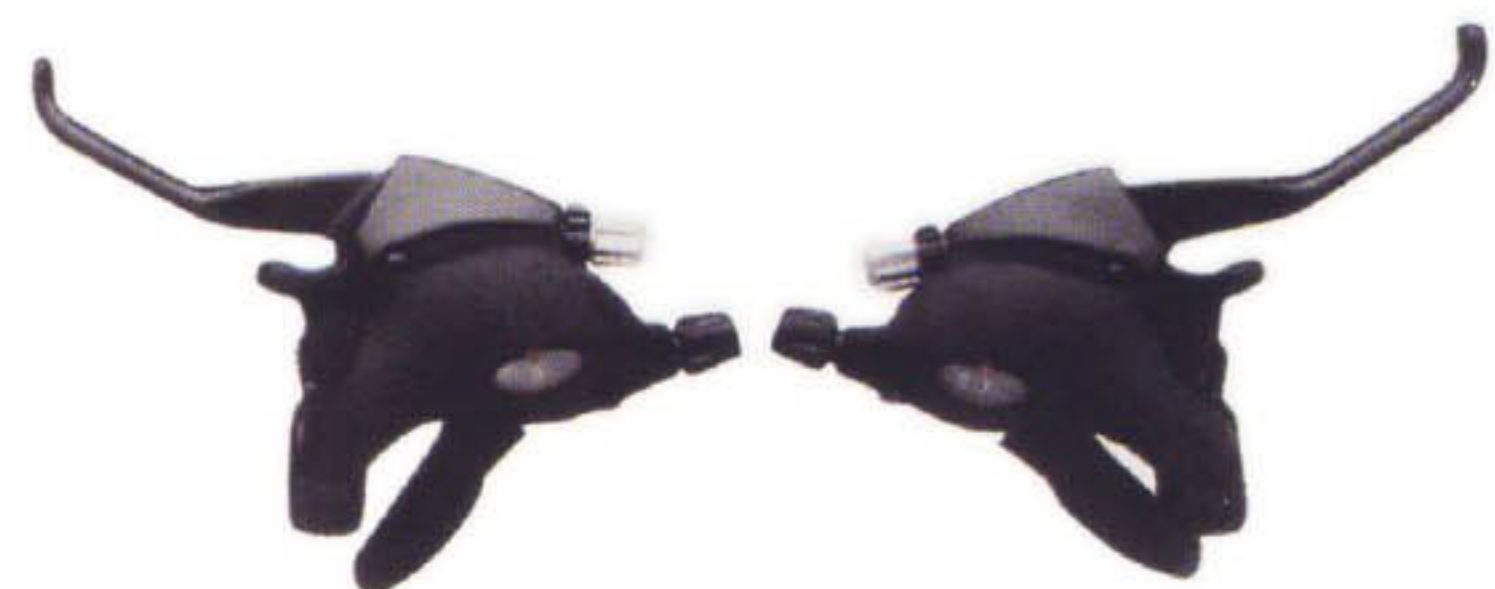

GTS-SM-03
TWIST DUAL INDEX SHIFTER
 with Brake Lever alloy, Clamp dia 22.2mm
 18/21/24 spd



CHAIN & FREEWHEEL

GURSAM



GCNY-001

CHAIN

PIN LENGTH : 7.8mm

TENSIL STRENGTH : 900kgs

COLOR : Brown

Detailed Product Description

1. Bushingless Construction
2. Inner Plate Chamfering
3. Compatible Bikes : 12-18 Speed Non-index System



GCNY-001

CHAIN

PIN LENGTH : 8.7mm

TENSIL STRENGTH : 820kgs

COLOR : Brown

Detailed Product Description

1. Bushingless Construction
2. Inner Plate Chamfering
3. Compatible Bikes : Single-Speed Bikes, BMX



GI-SSFW-07

FREEWHEEL

16T Full Ball

Finish : Brown/CP/BED



GI-SSFW-08

FREEWHEEL

18T Full Ball

Finish : Brown/CP/BED



GI-SSFW-09

FREEWHEEL

20T Full Ball

Finish : Brown/CP/BED



GI-SSFW-11

FREEWHEEL

22T Full Ball

Finish : Brown/BED



GI-SSFW-14

FREEWHEEL

24T Full Ball

Finish : Brown/BED

FREEWHEEL



GI-MSFW01
FREEWHEEL
Freewheel 5 Speed Friction.
Finish : Brown/ Black/ CP



GI-MSFW02
FREEWHEEL
Freewheel 6 Speed Friction.
Finish : Brown/ Black/ CP



GI-MSFW03
FREEWHEEL
Freewheel 7 Speed Friction.
Finish : Brown/ Black/ CP



GI-MSFW04
FREEWHEEL
Freewheel 6 Speed Index
Finish : Brown/ Black/ CP



GI-MSFW05
FREEWHEEL
Freewheel 7 Speed Index
Finish : Brown/ Black/ CP



GI-MSFW28
FREEWHEEL
Freewheel 8 Speed Friction
Finish : Brown/ Black/ CP



GI-MSFW29
FREEWHEEL
Freewheel 5 Speed Index
Finish : Brown/ Black/ CP

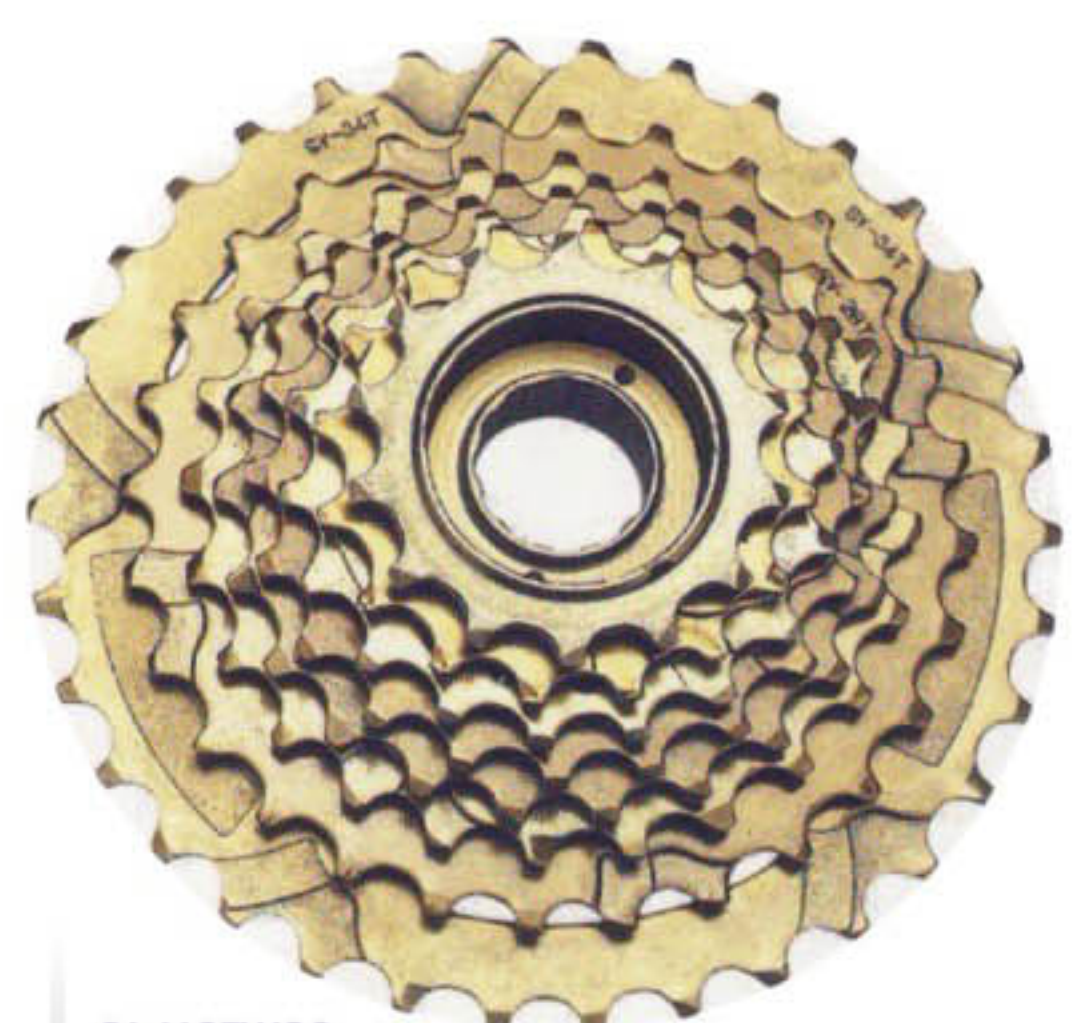

GI-MSFW29
FREEWHEEL
Freewheel 8 Speed Index
Finish : Brown/ Black/ CP





GBN-DV01

V-BRAKE

DESC : V-Brake Nylon with steel insertion.
Arm length 105, 110, 115mm

Finish : Black/ Colors to order



GBN-DV13

V-BRAKE

DESC : V-Brake Nylon with steel insertion.
Arm length 105, 110, 115mm. Brake Shoe Orbital

Finish : Black/ Colors to order



GBN-DV03

V-BRAKE

DESC : V-Brake Nylon with steel insertion.
Arm length 105, 110, 115mm. Brake Shoe Orbital

Finish : Black/ Colors to order



GBN-DV14

V-BRAKE

DESC : V-Brake Nylon with steel insertion.
Arm length 105, 110, 115mm. Brake Shoe Orbital

Finish : Black/ Colors to order



GBN-DV05

V-BRAKE

DESC : V-Brake steel. Arm length 105, 110, 115mm
Brake shoe orbital or normal

Finish : Black/ Colors to order



GBS-SP101

CALIPER BRAKE

Steel Sheet thickness 3mm/ 3.5mm/ 4mm

Finish : Black/ CP

BRAKE



GBA-C02
V-BRAKE
 DESC : Caliper Brake alloy
 Finish : Black/Colors



GBA-V82
V-BRAKE
 DESC : V-Brake alloy with orbital Brake Shoes.
 Arm Length 110mm
 Finish : Silver/ Colors



GBA-V04
V-BRAKE
 DESC : V-Brake alloy with orbital Brake Shoes.
 Arm Length 110mm
 Finish : Silver/ Colors



GBA-U02
U-BRAKE ALLOY
 Finish : Silver/ Colors



GBA-V05
V-BRAKE
 DESC : V-Brake alloy. Arm Length 110mm
 Finish : Silver/ Colors

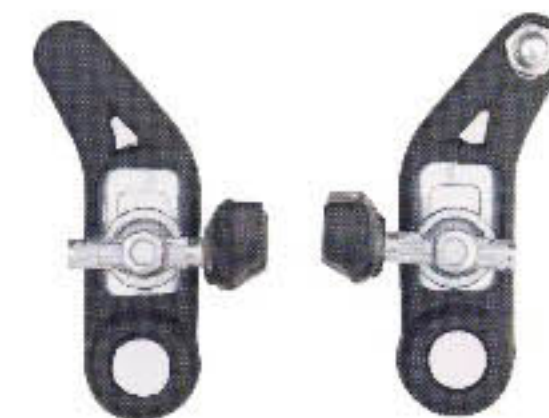

GBN-C101
CANTILEVER BRAKE
 Cantilever Brake Nylon
 with steel insertion without bush
 Finish : Black/ Colors to order



GBN-C102
CANTILEVER BRAKE
 Cantilever Brake Nylon
 with steel insertion with bush
 Finish : Black/ Colors to order



GBA-CB06
CANTILEVER BRAKE ALLOY
 Finish : Silver/ Colors



BRAKE LEVER

CURSAM



GBL-A204
BRAKE LEVER
DESC : 3 Fingers steel Brake Lever
with returning spring
Finish : CP/ ED



GBL-A213
BRAKE LEVER
DESC : 3 Fingers steel Brake Lever
with returning spring
Finish : CP/ ED



GBL-AV07
BRAKE LEVER
DESC : Nylon 2 Finger Brake Lever
with returning spring
Finish : BLK/ Colors to order



GBL-A605
BRAKE LEVER
DESC : Nylon 2 Finger Brake Lever
with returning spring
Finish : BLK/ Colors to order



GBL-AV01
BRAKE LEVER
DESC : Nylon 2 Finger Brake Lever
with returning spring
Finish : BLK/ Colors to order



GBL-A615
BRAKE LEVER
DESC : Nylon 3 Finger Brake Lever
with returning spring
Finish : BLK/ Colors to order



GBL-AV02
BRAKE LEVER
DESC : Nylon 2 Finger Brake Lever
with returning spring
Finish : BLK/ Colors to order



GBLA-B19
BRAKE LEVER
DESC : Brake Lever Half Alloy
with Nylon Bracket
Finish : Silver/ Colors

CHAINWHEEL



GBLA-B08
BRAKE LEVER
DESC : Brake Lever Half Alloy
with Nylon Bracket
Finish : Silver/ Colors



GBLA-B01
BRAKE LEVER
DESC : Brake Lever Full Alloy
Finish : Silver/ Colors



GBLA-B02
BRAKE LEVER
DESC : Brake Lever Full Alloy
Finish : Silver/ Colors



GBLA-B09
BRAKE LEVER
DESC : Brake Lever Full Alloy
Finish : Silver/ Colors



GBL-A618
BRAKE LEVER
DESC : Racing steel lever with light alloy &
bracket clamp dia 22.2mm
Finish : CP/ Bik



GBLA-B17
BRAKE LEVER
DESC : Brake Lever Full Alloy
Finish : Silver/ Colors





GDRE-16
DISC BRAKE ROTOR
 DESC : Stainless Steel, UNS 420
 Diameter : 140mm, 160mm, 180mm
 Without flange



GDRC-16
DISC BRAKE ROTOR
 DESC : Stainless Steel, UNS 420
 Diameter : 140mm, 160mm, 180mm
 With flange



GDRA-16
DISC BRAKE ROTOR
 DESC : Stainless Steel, UNS 420
 Diameter : 120mm/140mm/160mm/180mm
 Without flange



GDR-16
DISC BRAKE ROTOR
 DESC : Stainless Steel, UNS 420
 Diameter : 140mm, 160mm, 180mm
 With flange



GFDCA-09
DISC BRAKE CALIPER
 DESC : Alloy 6061, T6, Dual Side tool free pads adjusting system and barrel cable adjuster. Compatible with 51mm and 74mm pillar type. Two way installation.
 Rotor Options: 180/160mm, 160/160mm, 160/140mm
 Finish : Anodic Oxidation



GMDCA-09
DISC BRAKE CALIPER
 DESC : Disc Brake Caliper. Alloy A356.
 Pad adjusting system and barrel cable adjuster
 Finish: Powder Coating





GKL-01
BB Axle
 Cotterless Nut type, Available Material Cr-Mo/C45/10B21
 Available Finish BED/BLACK/UCP, Length- See reference table



GKL-02
BB Axle
 Cotterless Bolt Type, Available Material Cr-Mo/C45/10B21
 Available Finish BED/BLACK/UCP, Length- See reference table

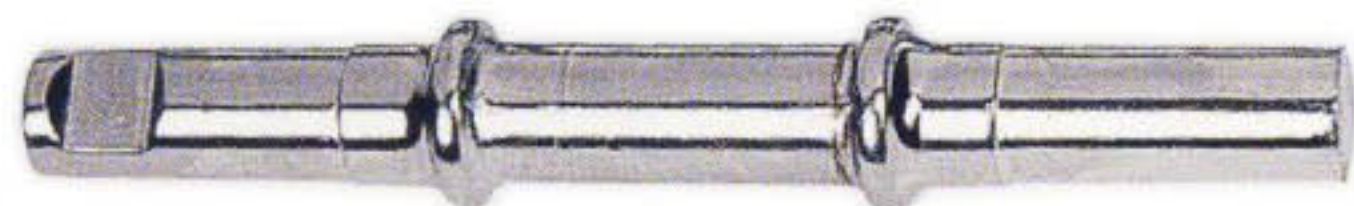

GKL-03
BB Axle
 Cotterless Bolt Type, Available Material Cr-Mo/C45/10B21
 Available Finish BED/BLACK/UCP, Length- See reference table



GKL-A
BB Axle
 Thomson type set of 9 pcs
 (Steel 20# cottered spindle, steel cups, ball retainers,)
 Cup size- 35mm(3717), 40mm(3720), Ball retainers 3/16x8 & 15/64x10,
 Length 148mm



GKL-08B
BB Cartridge
 with ball bearings 1/4"x9
Thread : 1.37x24TPI L/R & M36X24TPI R/R
 Available in material Cr Mo & 10B21,
 Available in BNCP/ED, cotterless spindle



GKL-08E
Threadless BB Set
 cotterless spindle ,
 alloy body with sealed bearings 18x28x7 @ 35mm,
 optional finish



GKL-08A
BB Cartridge
 with sealed bearings
Thread : 1.37x24TPI L/R & M36X24TPI R/R
Bearing size : 16x31x10
 Available in material Cr Mo & 10B21,
 Available in BNCP/ED, cotterless spindle



GKL-09A
Cr-Mo Cotterless Spindle
 with alloy body 2 pcs, 2 pcs sealed bearings 16x31x10,
Thread size : 1.37"X24 L/R ,
 Finish: Black spindle, CP cups



GKL-101
Nylon Body Spindle
 2 pcs alloy cups,
 with 2 pcs sealed bearings 25x37x7,
Thread size : 1.37"X24t L/R



Reference Dimension Table

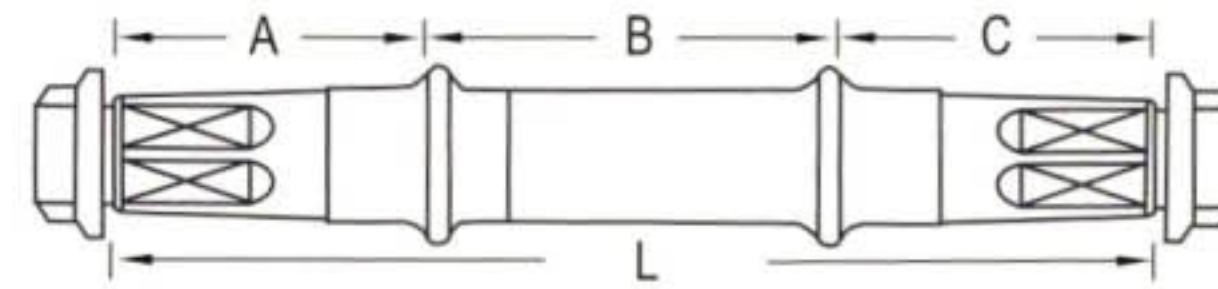
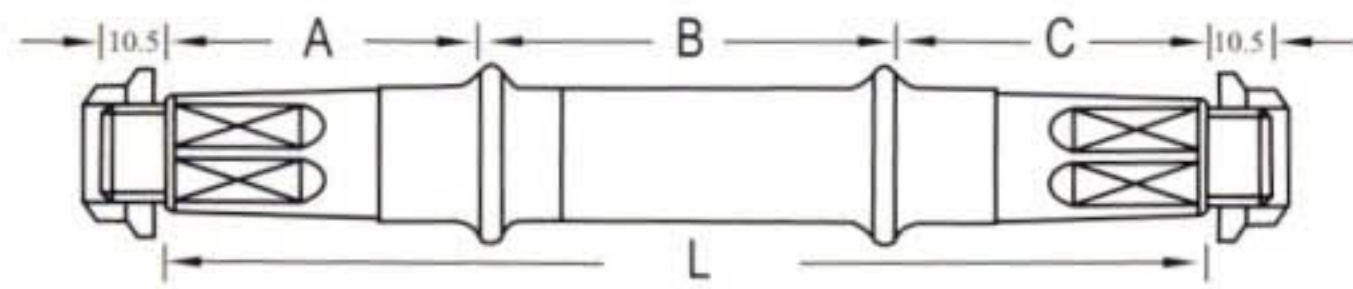

Nut & Bolt Type Cotterless Axle

Model	3H	3M	3E	3J	3C	3L	3A	3P	3N	3SS	3Z	3PL	3S	3T	3U	3R	3UM	3RM	3L	5P	5S	5T	5U	5R	7L	7P	7S	7T	7U	7R
Bracket Width	68	68	68	68	68	68	68	68	68	68	68	68	68	68	68	68	68	68	70	70	70	70	70	70	73	73	73	73	73	73
A	28	28	28	30.5	30.5	32	32	32	32	32	33.5	35	35	35	35	35	37.5	37.5	32	32	35	35	35	35	32	32	35	35	35	35
B	52	52	52	52	52	52	52	52	52	52	52	52	52	52	52	52	52	52	54	54	54	54	54	54	57	57	57	57	57	57
C	28	28	30.5	30.5	32	32	33.5	35	36	37.5	33.5	35	37.5	39	40.5	42	40.5	42	32	35	37.5	39	40.5	42	32	35	37.5	39	40.5	42
Axle Length	108	108	110.5	113	114.5	116	117.5	119	120	121	119	122	124.5	126	127.5	129	130	131.5	118	121	126.5	128	129.5	131	121	124	129.5	131	132.5	134

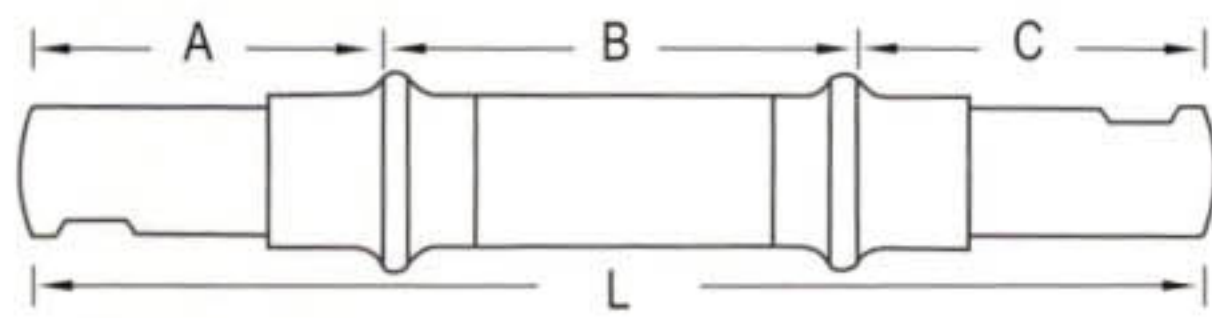

Cottered Axle

Model	K830	K831	K832	K833	K834	K835	K836	K837	K838	K839	K850	K851	K852	K853	K854	K855	K856	K857	K858	K859
Bracket Width	68	68	68	68	68	68	68	68	68	68	70	70	70	70	70	70	70	70	70	70
A	35	40	41	43	43	45	45	48	50	50	40	41	41	43	43	45	48	50	51	50
B	52	52	52	52	52	52	52	52	52	52	55	55	55	55	55	55	55	55	55	55
C	46	46	46	48	52	50	51	51	50	52	48	49	51	48	51	45	48	50	51	52
Axle Length	133	138	139	143	147	147	148	151	152	154	143	145	147	146	149	145	151	155	157	157

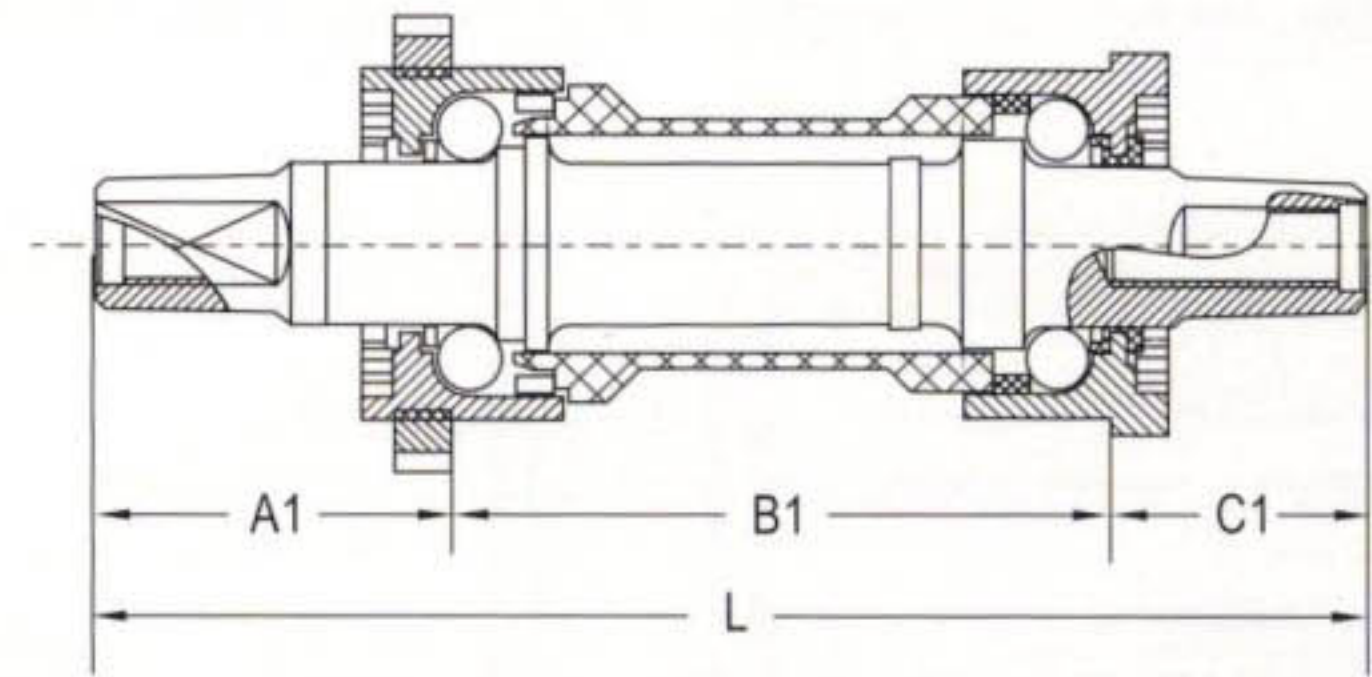
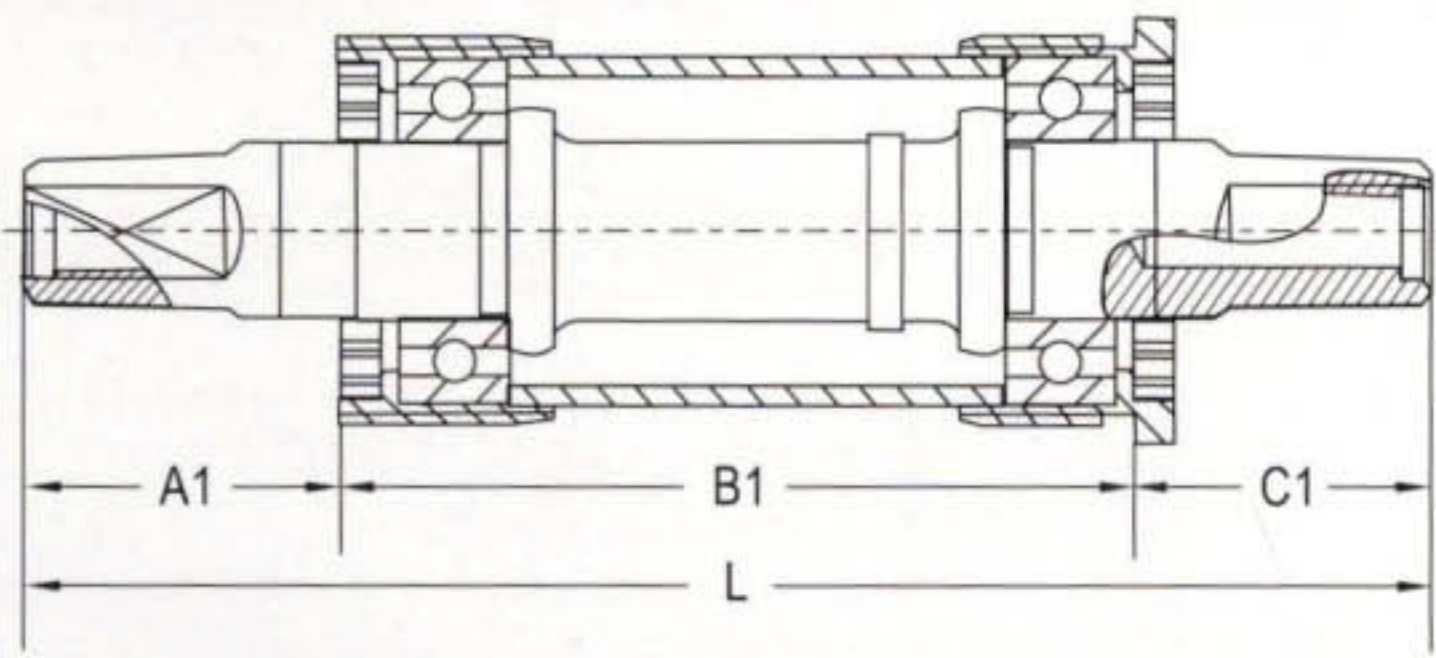

Cartridge Bearing B.B.Set

Model	2HH	2H	2M	2E	2J	2L	2A	2P	2N	2SS	2PL	2S	2T	2U	2R	2UM	4E	4M	4J	4L	4A	4P	4N	4SS	4PL	4S	4T	4U	4R	4UM
Bracket Width	68	68	68	68	68	68	68	68	68	68	68	68	68	68	68	68	70	70	70	70	70	70	70	70	70	70	70	70	70	70
A1	17	19.5	19.5	21	23	24	25	24	24	24	27.5	27	26.5	26.5	27	29.5	20	20	21	23	23	23	23	23	26.5	25.5	26	25.5	26	28.5
B1	68	68	68	68	68	68	68	68	68	68	68	68	68	68	68	68	70	70	70	70	70	70	70	70	70	70	70	70	70	
C1	18	19.5	20.5	21	22	24	25	27	28	29.5	26.5	29	31.5	32.5	34	32.5	20	21	22	23	25	26	27	28.5	25.5	28.5	30	31.5	33	31.5
Axle Length	103	107	108	110	113	116	118	119	120	121.5	124	124	126	127	129	130	110	111	113	116	118	119	120	121.5	122	124	126	127	129	130

HOLLOW ISIS

Model No.	A1	D1	C1	C3	L	Spacer	Weight(g)
	20	68	20	54	108	-	148
	22.5	68	22.5	56.5	113	2.5	158
	25	68	25	59	118	2.5	169
Model No.	A2	D2	C2	C2	L	Spacer	Weight(g)
KL-09D/73/113	20	73	20	56.5	113	-	158
KL-09D/73/1118	22.5	73	22.5	59	118	-	169

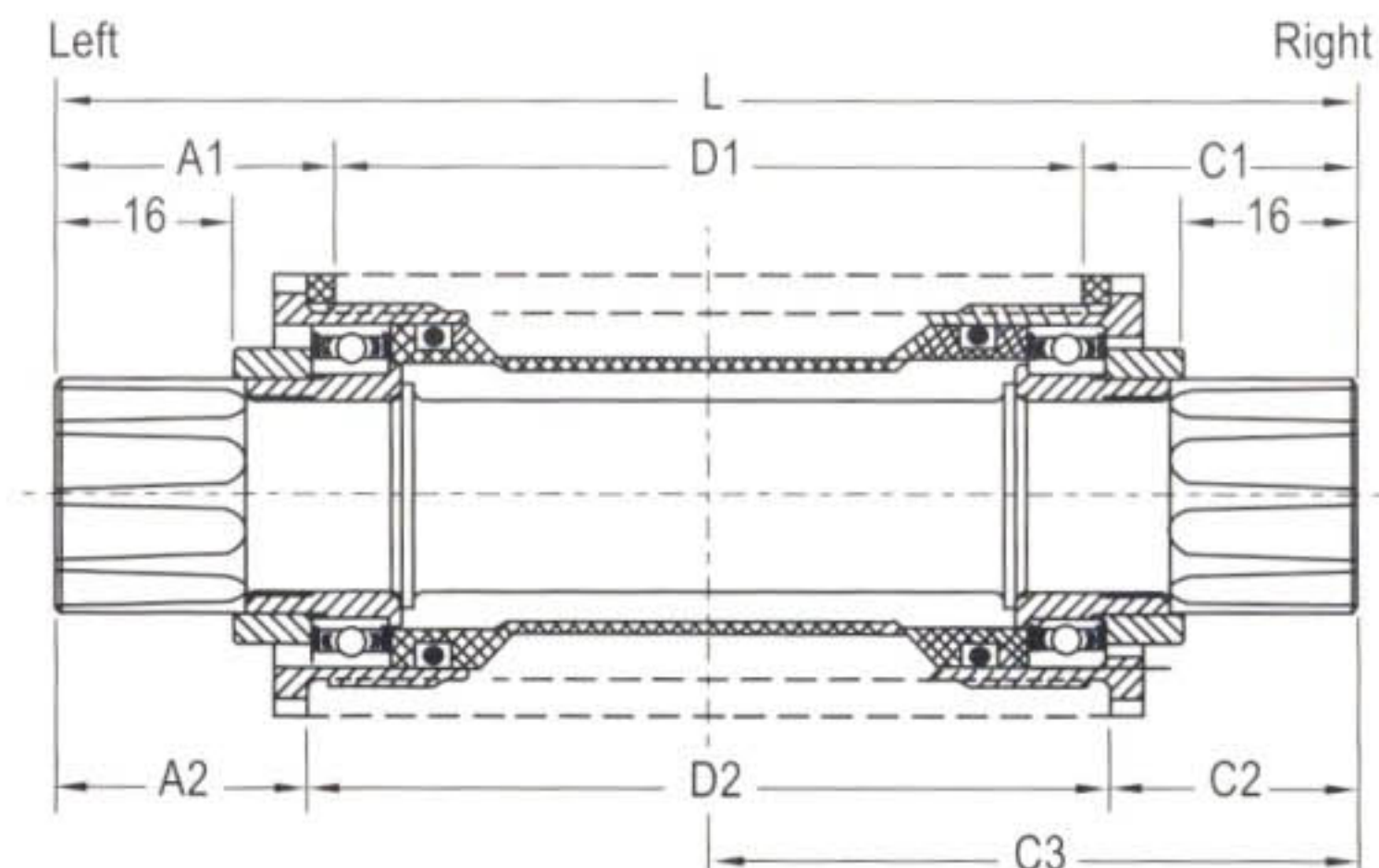



GKL-B4
BB CUP SET 5 PCS
Phillips Type
Ball Retainers : 1/4"x9
Thread Size : 1.37"X24L/R
Available Finish : ED/UCP/BNCP



GKL-B32
BB CUP SET 5 PCS
Notch Type
Ball Retainers : 1/4"x9
Thread Size : 1.37"X24 L/R
Available Finish : ED/UCP/BNCP



GKL-B39
BB CUP SET 5 PCS
Hex Type
Ball Retainers : 1/4"x9
Thread Size : 1.37"X24 L/R(M36X24R/R)
Available Finish : ED/UCP/BNCP



GKL-B39+
BB CUP SET 5 PCS
Hex Type With water seals
Ball Retainers : 1/4"x9
Thread Size : 1.37"X24 L/R(M36X24R/R)
Available Finish : ED/UCP/BNCP

B.B. CUP



GKL-B451

BB Cup

With Brazil Thread & Dust Resistant Steel,
Bearings : 4525r-s,
Cups : 45mm,
Thread : M22x24t, M23.4x32t, Set Of 6 Pcs ,
Finish : ED/UCP/CP



GKL-B451A

BB Cup

With Brazil Thread & Dust Resistant Steel
Ball Retainers : 15/64x10
Cups : 45mm
Thread : M22x24T, M23.4x32T, Set Of 10 Pcs
Finish : ED/UCP/CP



GKL-B515

BB Cup

BB Fitting American type Steel with
Ball retainers : 5/16"x9
Cups : 51.5mm
Thread size : 7/8"x24tl(15/16"x24r), Set of 9 pcs
Finish : ED/UCP



GKL-B515C

BB Cup

American type Steel with ball bearings 6906R-S
Cups : 51.5mm
Thread size : 7/8"x24TL(15/16"x24TR)
 Set of 11 pcs
Finish : ED/BNCP



GKL-B451

BB Cup

BB Cup with Brazil Thread & dust resistant steel,
Bearings : 4525R-S
Cups : 45mm
Thread : M22X24T, M23.4X32T, Set of 6 pcs
Finish : ED/UCP/CP



GKL-B451A

BB Cup

BB Cup with Brazil Thread & dust resistant steel,
BALL RETAINERS : 15/64x10
Cups : 45mm
Thread : M22X24T, M23.4X32T, Set of 10 pcs
Finish : ED/UCP/CP





GKL-B203
Head Set
 Fork fitting steel
 Thread : BC1"X24T,
 Dia : 22/30/27mm,
 Ball Retainers : 5/3" 2x16, set of 8 pcs,
 Height : 42mm
 Available finish : CP/ED



GKL-B204
Head Set
 Fork fitting steel
 Thread : BC1"X24T,
 Dia : 22/30/27mm,
 Ball Retainers : 5/3" 2x16, set of 8 pcs,
 Height : 42mm
 Available finish : CP/ED



GKL-B205
Head Set
 Fork Fitting Steel
 Thread : BC1"X24T
 Dia : 22/30/27mm
 Ball Retainers : 5/3" 2x16, set of 8 pcs
 Height : 38mm
 Available finish : CP/ED



GKL-B206
Head Set
 Fork fitting water resistant steel
 Thread : BC1"X24TPI & 1-1/8"X26TPI
 Dia : 25.4/34/30mm
 Ball retainers : 5/32x20, set of 9 pcs
 Height : 38mm
 Available finish : BNCP/ED



GKL-B207
Head Set
 Threadless Fork Fitting Steel
 Size : 101/8"
 Dia : 28.6/30/34
 Ball retainers : 5.32x20, set of 10 pcs
 Height : 26mm
 Available finish : BNCP/ED

HEAD SET



GKL-B208
Head Set
 Alloy Threadless Fork Fitting
Size : 1-1/8"threadless
Dia : 28.6/30/34mm
Ball retainers : 5/32x20 , set of 9 pcs
Height : 28mm
Finish : Optional



GKL-B209
Head Set
 Alloy Threadless Fork Fitting
Size : 1-1/8" threadless,
Dia : 28.6/30/34mm,
Ball Bearings : 30x41x6.5mm,Set Of 9 Pcs,
Height : 32mm,
Finish : Optional



GKL-B211
Head Set
 Threadless Fork Fitting Water Resistant Steel
Size : 1-1/8"
Dia : 28.6/30/44mm
Ball Retainers : 5/32"x22, Set Of 10 Pcs
Height : 11mm
Availbale In : BNCP/ED Finish



GKL-B216
Head Set
 Fork Fitting Steel
Size : 1-1/8" Threadless
Dia : 28.6/30/44mm
Ball Retainers : 5/32x22, Set Of10 Pcs
Height : 24mm
Finish : Optional



GKL-B221
Head Set
 Threadless Concealed Head Set Alloy
Size : 1-1/8"
Bearings : 30x41x6.5mm, Set Of 6 Pcs
Height : 31mm
Finish : Optional



CABLE WITH HEAD

CURSAM



GKY-301

- A : Φ 8x11 Head 2.0mm Cable for MTB
- B : Φ 8x8 Head 2.0mm Cable for MTB
- C : Φ 6x10 Head 1.5mm Cable for BMX
- D : Φ 7x7 Head 1.5mm Cable for BMX
- E : Φ 6x7 Head 1.5mm Cable for Racing
- F : Φ 7x6 Head 1.5mm Cable for ATB



GKY-302

- A : Φ 8x11 Head 2.0mm Cable for Motorcycle
- B : Φ 6x11 Head 1.5mm Cable for Racing
- C : Φ 6x10 Head 1.5mm Cable for Racing
- D : Φ 6x9 Head 1.5mm Cable for Racing
- E : Φ 6x8 Head 1.5mm Cable for Racing



GKY-303

- A : Φ 5x10 Head 1.5mm Cable
- B : Φ 6 Head 1.5mm Cable
- C : Φ 4 Head 1.5mm Cable
- D : Φ 7x6 Head 1.5mm Cable
- E : Φ 9.5x9 Head MTB Yoke Wire for Cantilever Brakes
- F : Φ 7x6 Head 1.5mm Cable

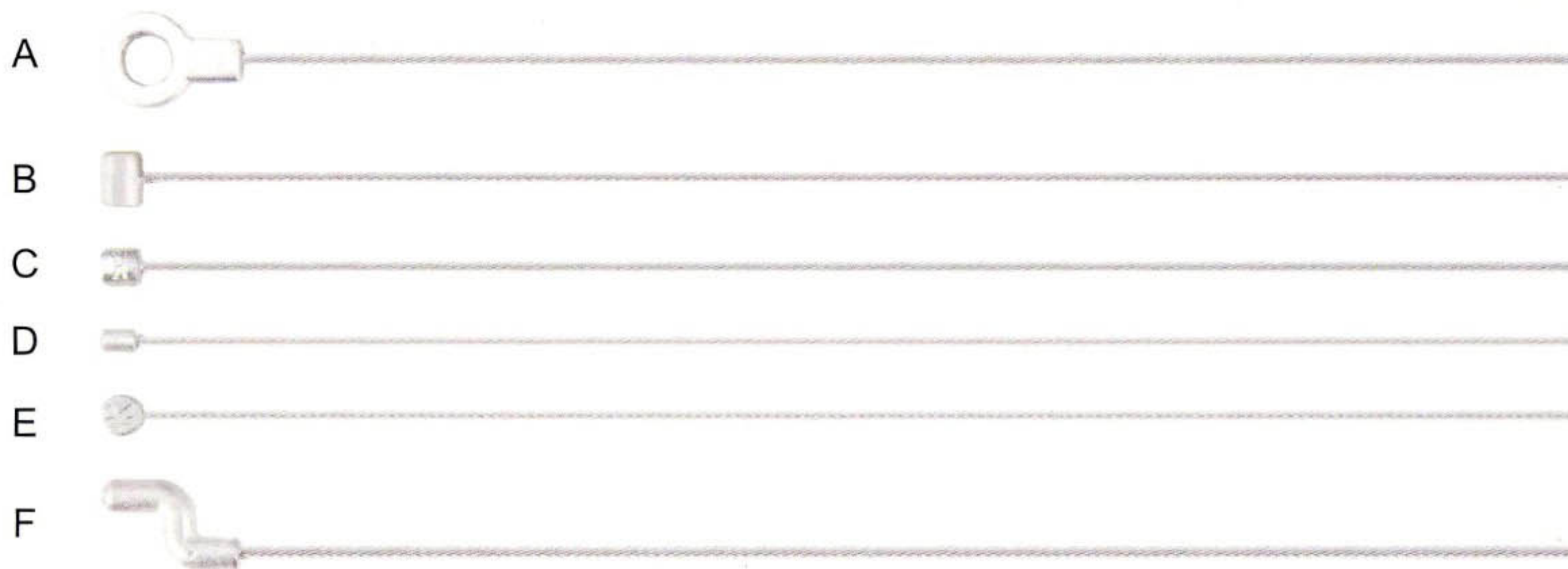

GKY-304

- A : Φ Cable for Children Brake
- B : Φ 5x6 Head 1.2mm Cable
- C : Φ 4.5x4.5 Head 1.2mm Cable
- D : Φ 3x4 Head 1.2mm Cable
- E : Φ 5x3 Head 1.2mm Cable
- F : Φ 2.5x12 Head 1.2mm Cable

OUTER CASING

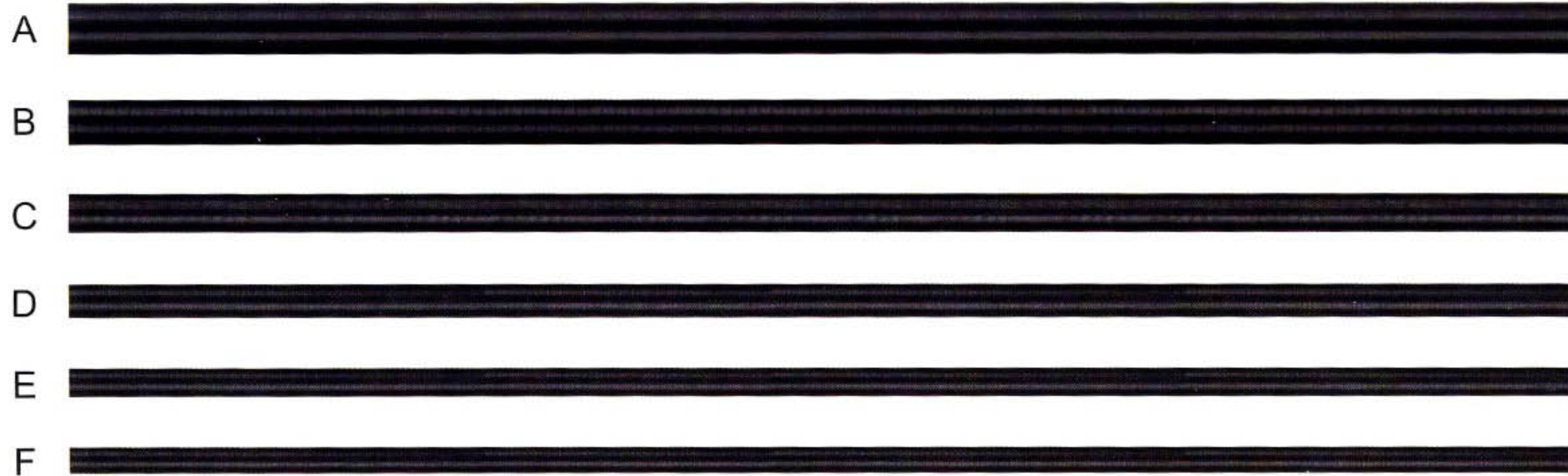

GKY-201

- A : Φ 10mm 1P,2P Outer Casing
 - B : Φ 9mm 1P,2P Outer Casing
 - C : Φ 8mm 1P,2P Outer Casing
 - D : Φ 7mm 1P,2P Index Series
 - E : Φ 6mm 1P,2P Index Series
 - F : Φ 5mm 1P,2P Index Series
- 500m, 200m, 100m, 50m, 25m Per Roll

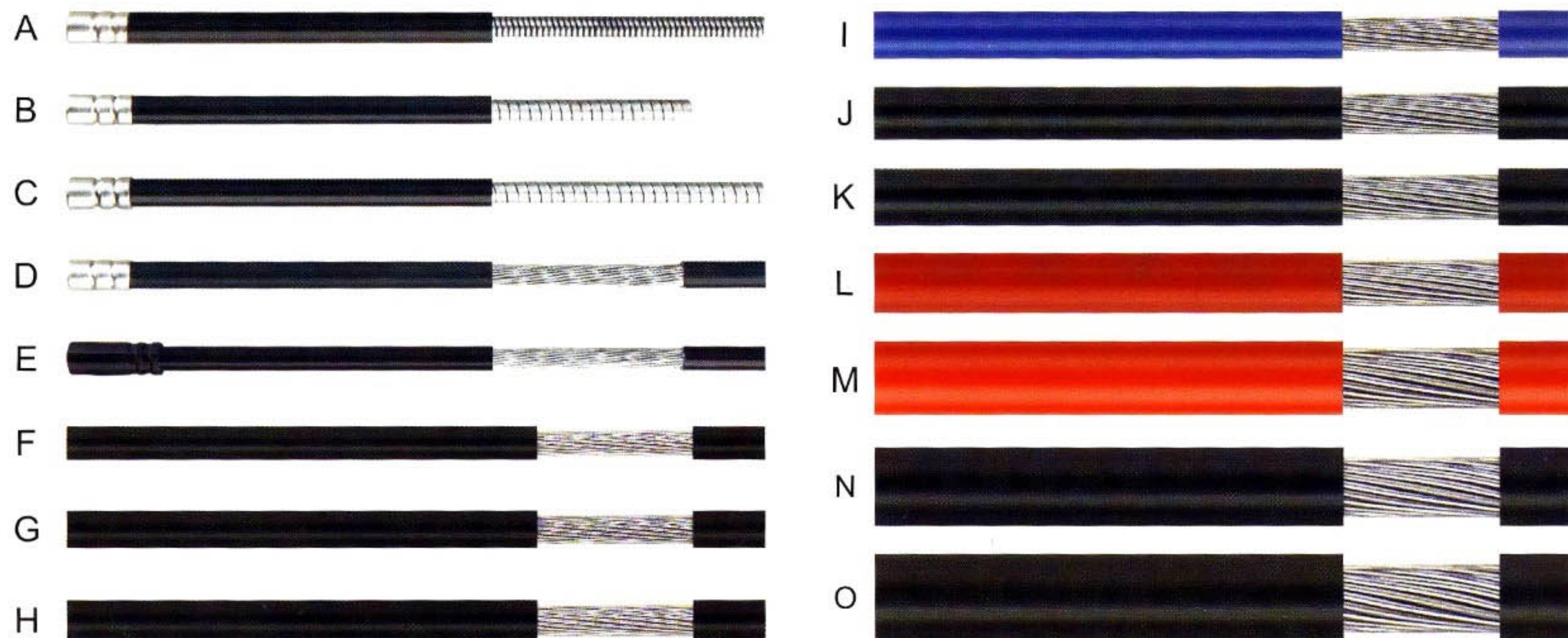

GKY-202

- | | | |
|------------------------------------|---------------------------------|---------------------------------|
| A : Φ 5mm Round Thread Casing | F : Φ 6mm SP Index Series | K : Φ 11mm SP Index Series |
| B : Φ 5mm 2P Outer Casing | G : Φ 7mm SP Index Series | L : Φ 12mm SP Index Series |
| C : Φ 5mm 1P Outer Casing | H : Φ 8mm SP Index Series | M : Φ 13mm SP Index Series |
| D : Φ 5mm SP Index Series | I : Φ 9mm SP Index Series | N : Φ 14mm SP Index Series |
| E : Φ 4mm SP Index Series | J : Φ 10mm SP Index Series | O : Φ 15mm SP Index Series |

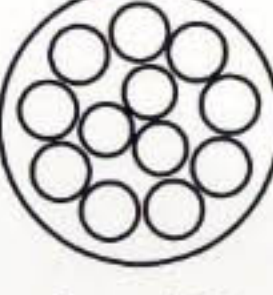
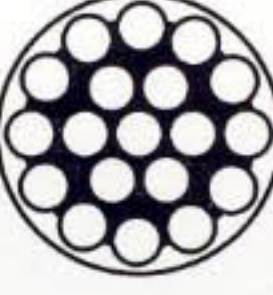
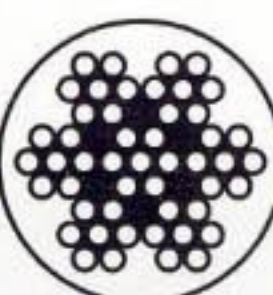

Galvanized Steel Wire

Constuction	Nominal Diameter (mm)	Min.Breaking Strength (kN)	Approximate Weight (kg/100m)
 1 x 12	1.0	1.05	0.49
	1.2	1.50	0.70
	1.4	2.00	0.95
	1.5	2.30	1.09
	1.6	2.50	1.24
	1.8	3.10	1.56
 1 x 19	1.0	1.06	0.52
	1.2	1.52	0.74
	1.4	2.08	0.96
	1.5	2.39	1.14
	1.6	2.59	1.28
	1.8	3.29	1.60
	2.0	4.06	1.96
	2.5	6.01	3.07
	2.8	7.53	3.90
	3.0	8.63	4.46
 7 x 7	1.4	1.76	0.87
	1.5	1.99	0.98
	1.6	2.29	1.13
	1.7	2.81	1.35
	2.0	3.38	1.67
	2.5	5.45	2.70
	2.8	6.45	3.32
	3.0	7.28	3.77
	3.5	10.37	5.30

Stainless Steel Wire

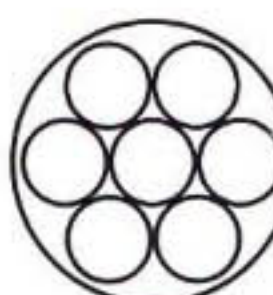
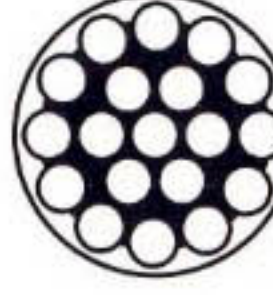
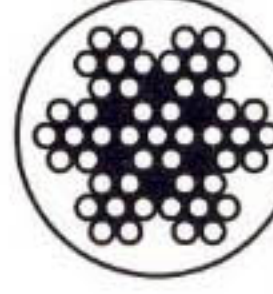
Constuction	Nominal Diameter (mm)	Tensile Strength (MPa)	Approximate Weight (kg/100m)
 1 x 7	0.6	1770	0.19
	0.8	1770	0.33
	1.0	1770	0.52
	1.5	1570	1.16
	2.0	1570	2.07
	3.0	1570	4.66
	4.0	1570	8.27
 1 x 19	5.0	1570	12.98
	1.0	1770	0.51
	1.5	1770	1.14
	2.0	1770	2.04
	2.5	1570	3.19
	3.0	1570	4.59
	4.0	1570	8.17
 7 x 7	1.4	1.76	0.87
	1.5	1.99	0.98
	1.6	2.29	1.13
	1.7	2.81	1.35
	2.0	3.38	1.67
	2.5	5.45	2.70
	2.8	6.45	3.32
	3.0	7.28	3.77
	3.5	10.37	5.30



HANDLE STEMS

GURSAM



GHSS-601
STEEL HANDLE STEM
 Sheet thk : 1.4mm Length : 150/180mm
 Extension : 60-100mm
 Diameter : 21.2mm/22.2mm/25.4mm
 Finish : CP or ED



GHSS-602
STEEL HANDLE STEM
 Sheet thk : 1.4mm Length : 150/180mm
 Extension : 60-100mm
 Diameter : 21.2mm/22.2mm/25.4mm
 Finish : CP or ED



GHSS-603
STEEL HANDLE STEM
 Sheet thk : 1.4mm Length : 150/180mm
 Extension : 60-100mm
 Diameter : 21.2mm/22.2mm/25.4mm
 Finish : CP or ED



GHSS-604
STEEL HANDLE STEM ZOOM
 Sheet thk : 1.4mm Length : 150/180mm
 Extension : 60-100mm
 Diameter : 21.2mm/22.2mm/25.4mm
 Finish : CP or ED



GHSS-606
STEEL HANDLE STEM BRASILIAN MODEL
 Sheet thk : 1.4mm Length : 150-300mm
 Extension : 30mm
 Diameter : 21.2mm/22.2mm
 Finish : CP or ED



GHSS-613
STEEL HANDLE STEM BMX WITH ALLOY TOP
 Sheet thk : 1.4mm Length : 150-180mm
 Diameter : 21.1mm/22.2mm
 Finish : CP or ED



GHSA-Y09-04
ALLOY HANDLE STEM
 Finish : Silver or colored



GHSA-Y09-13
ALLOY HANDLE STEM
 Finish : Silver or colored



GHSA-Y09-19
ALLOY HANDLE STEM
 Finish : Silver or colored

HANDLE STEMS



GHSA-Y09-20
ALLOY HANDLE STEM
with adjustable raise
Finish : Silver or colored



GHSA-Y09-23
ALLOY HANDLE STEM
Finish : Silver or colored



GHSE-Y08-01
ALLOY STEM EXTENSION
Size : 90mm
Finish : Silver or colored



GHSE-Y08-06
ALLOY STEM EXTENSION
Size : 50mm
Finish : Silver or colored



GHSE-Y08-14
ALLOY STEM EXTENSION
Size : 100mm
Finish : Silver or colored



GHSE-Y08-18
ALLOY STEM EXTENSION
Size : 80-120mm
Finish : Silver or colored



GHSE-Y08-24
ALLOY STEM EXTENSION
Size : 100-120mm
Finish : Silver or colored



GHSE-Y15-03
ALLOY STEM EXTENSION
Finish : Silver or colored



GHSE-Y15-04
ALLOY STEM EXTENSION
Finish : Silver or colored





GHBS-801
STEEL HANDLE BAR MTB
Sheet Thk : 1.2mm Width : 440-620mm
Finish : CP/ED



GHBS-803
STEEL HANDLE BAR CTB
Sheet Thk : 1.2mm Width : 440-620mm
Bend Height : 35/60mm
Finish : CP/ED



GHBS-804
HANDLE BAR POTI MODEL
Sheet thk : 1.2mm Width : 500-650mm
Bend Height : 120mm
Finish : CP/ED



GHBS-805
HANDLE BAR STEEL BEACH MODEL
Sheet thk : 1.2mm Width : 500-650mm
Bend Height : 120mm
Finish : CP/ED

HANDLE



GHBS-812
Handle Bar BMX
Sheet Thk : 1.2mm Width : 540-680mm
Raise : 220mm
Finish : CP/ED



GHBS-854
HANDLE BAR BMX
with central support.
Width : 540-620mm
Finish : CP/ED



GHBS-855
HANDLE BAR BMX
with central support.
Width : 480-640mm
Finish : CP/ED



GHBS-856
Handle Bar Brazilian Type
with Expander Bolt
Finish : CP/ED



HANDLE



GHBA-Y07-01
HANDLE BAR CTB ALLOY
Length : 540-840mm
Finish : To Order



GHBA-Y07-05
HANDLE BAR CTB ALLOY
with Central Support.
Length : 540-840mm
Finish : To Order



SEAT POST



GSSP-501
STEEL SEAT POST STRAIGHT TYPE
Diameter : 22.2mm Length : to order.
Finish : Silver or colored



GSSP-502
STEEL SEAT POST REDUCED TYPE
Diameter : 25.4mm/ 27.2mm/ 28.6mm
Length : To order
Finish : Silver or colored



GSSP-551
STEEL SEAT POST BENDED
Diameter : 22.2mm/ 25.4mm/ 28.6mm.
Length : To order
Finish : Silver or colored



GSSP-552
STEEL SEAT POST BENDED
Diameter : 22.2mm/ 25.4mm/ 28.6mm.
Length : To order
Finish : Silver or colored



GSSP-553
STEEL SEAT POST BENDED
with Support
Diameter : 22.2mm/ 25.4mm/ 28.6mm.
Length : To order
Finish : Silver or colored



GASP-Y07-01
ALLOY SEAT POST REDUCED
Diameter : 25.4mm/27.2mm/28.6mm
Length : To order
Finish : Silver or colored



GASP-Y07-02
ALLOY SEAT POST BENDED
Diameter : 22.2mm/ 25.4mm/ 28.6mm.
Length : To order
Finish : Silver or colored



GASP-Y07-04
ALLOY SEAT POST WITH CLAMP
Diameter : 22.2mm/ 25.4mm/27.2mm/28.6mm.
Length : To order
Finish : Silver or colored



SEAT POST

CURSAM



GASP-Y07-05
ALLOY SEAT POST WITH CLAMP
 Diameter : 22.2mm/ 25.4mm/27.2mm/28.6mm
 Length : To order
 Finish : Silver or colored



GASP-Y07-06
ALLOY SEAT POST WITH SUSPENSION
 Diameter : 22.2mm/ 25.4mm/27.2mm/28.6mm
 Length : To order
 Finish : Silver or colored



GASP-Y07-14
ALLOY SEAT POST WITH SUSPENSION & CLAMP
 Diameter : 22.2mm/ 25.4mm/27.2mm/28.6mm
 Length : To order
 Finish : Silver or colored



GHBE-Y01-02
BAR ENDS ALLOY
 Finish : Silver or colored



GHBE-Y01-04
BAR ENDS ALLOY
 Finish : Silver or colored



GHBE-Y01-16
BAR ENDS ALLOY
 Finish : Silver or colored



GEBH-18
EXPANDER BOLT ALLEN TYPE
 Size : 21.1mm or 22.2mm
 Finish : CP,UCP or Blk



GEBH-19
EXPANDER BOLT HEX TYPE
 Size : 21.1mm or 22.2mm
 Finish : CP,UCP or Blk

STAND



GHX-Y10-01
KICK STAND ALLOY
 Adjustable
 Color : To Order



GHX-Y10-02
KICK STAND(STEEL)
 Adjustable
 Color : To Order



GHX-Y10-03
KICK STAND(STEEL)
 Adjustable
 Color : To Order



GHX-Y10-04
KICK STAND ALLOY
 Adjustable
 Size : 20/24/26/28"
 Color : To Order



GHX-Y10-05
KICK STAND ALLOY
 Adjustable
 Size : To Order
 Color : To Order



GHX-Y10-10
KICK STAND ALLOY
 Adjustable
 Size : To Order
 Color : To Order



GHX-Y10-13
KICK STAND ALLOY
 Adjustable
 Size : To Order
 Color : To Order



GHX-Y10-15
KICK STAND ALLOY
 Adjustable
 Size : To Order
 Color : To Order



GHX-Y13-05
SIDE STAND STEEL
 Adjustable
 Size : To Order
 Color : CP/UCP/BLK



GWB-01
WATER BOTTLE CAGE



GWB-02
WATER BOTTLE CAGE



GWB-01
DERAILLEUR GAURD



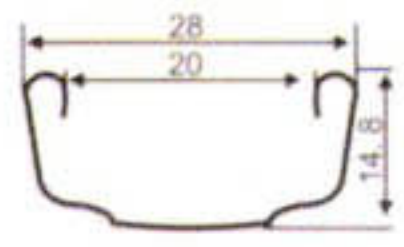

GR-S-004
STEEL RIM
 Sizes : 12-26" x 1.5-1.75
 Spoke Holes : 16/20/28/32/36H
 Finish : CP or ED

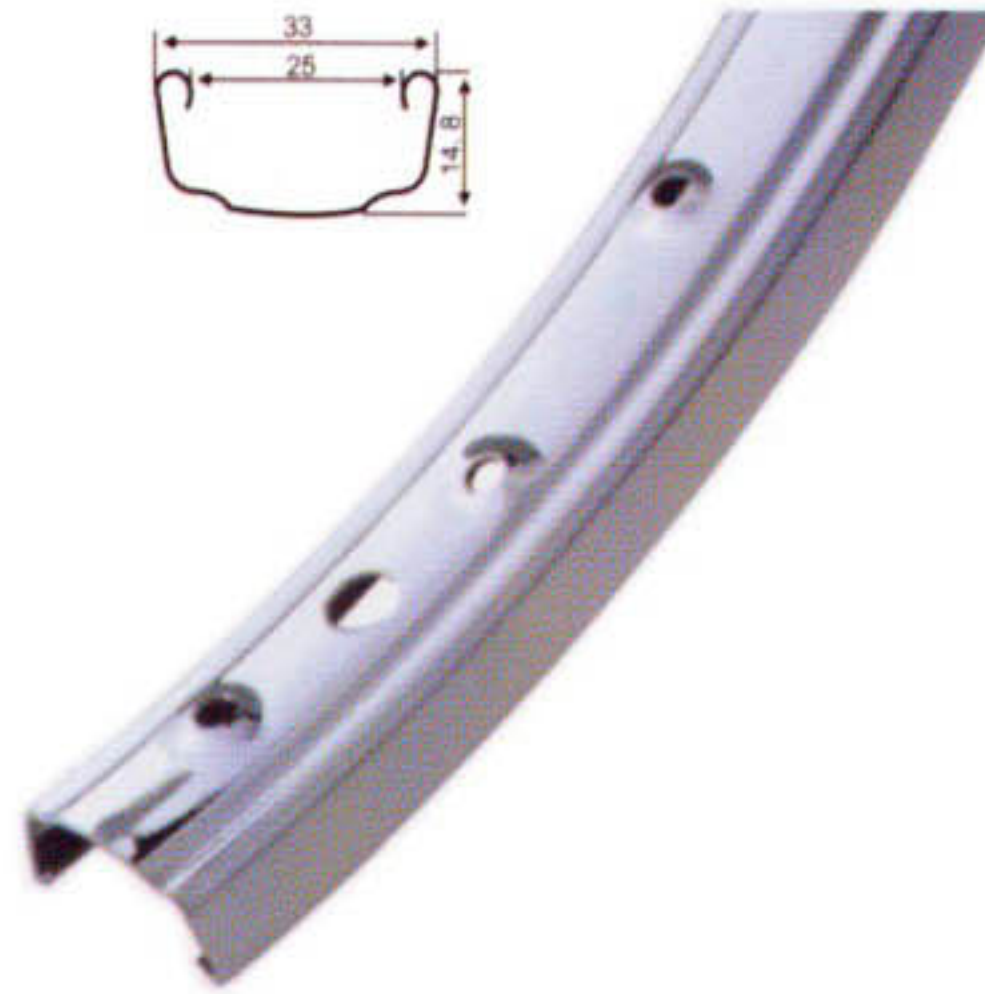
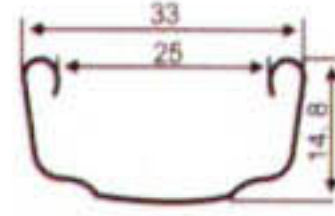

GR-S-007
STEEL RIM
 Sizes : 12-26" x 1.75-2.125
 Spoke Holes : 16/20/28/32/36H(7X profile)
 Finish : CP or ED

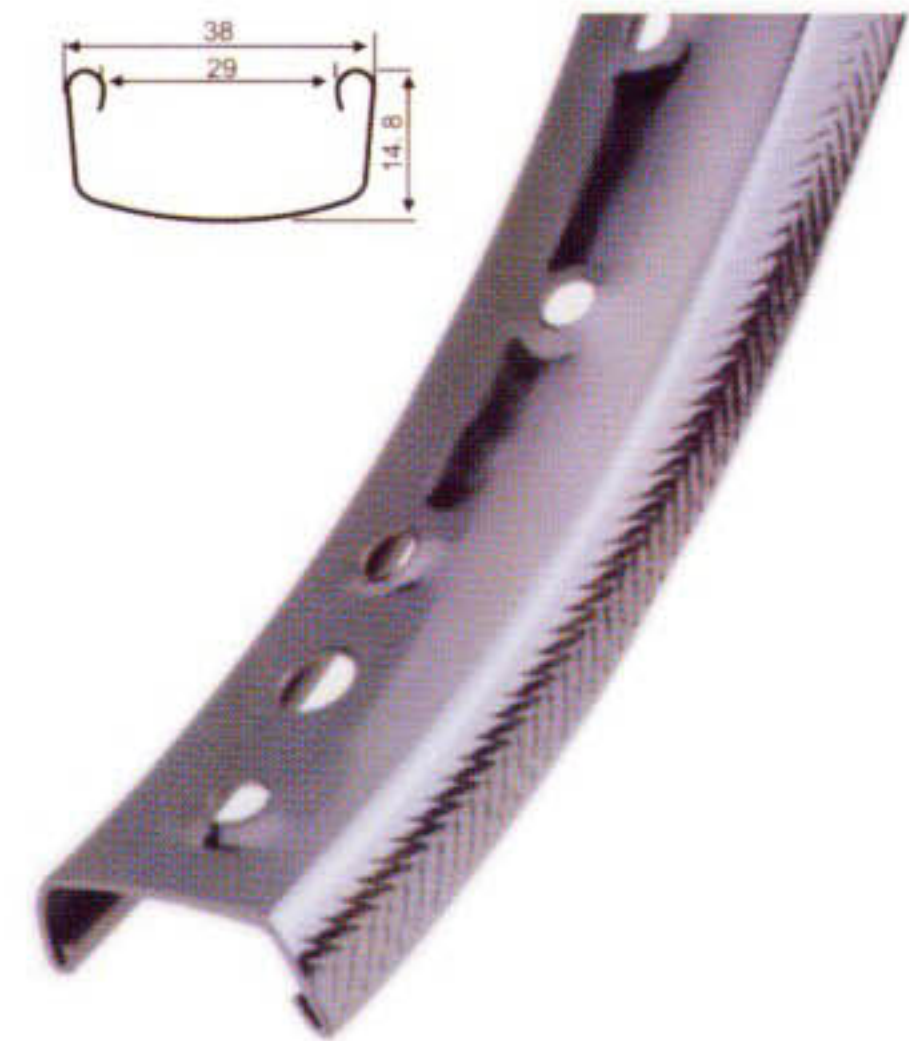
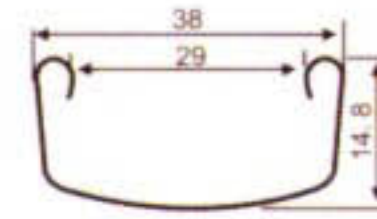

GR-S-010
STEEL RIM
 Sizes : 12-26" x 2.125
 Spoke Holes : 16/20/28/32/36H
 Finish : CP or ED

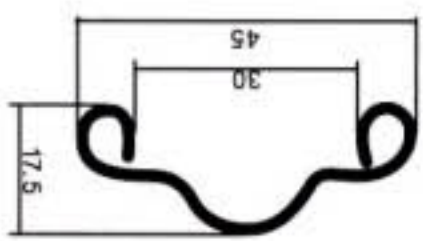

GR-S-011
STEEL RIM
 Sizes : 26/28 x 1-1/2
 Spoke Holes : 32/36/40H
 Finish : CP or ED

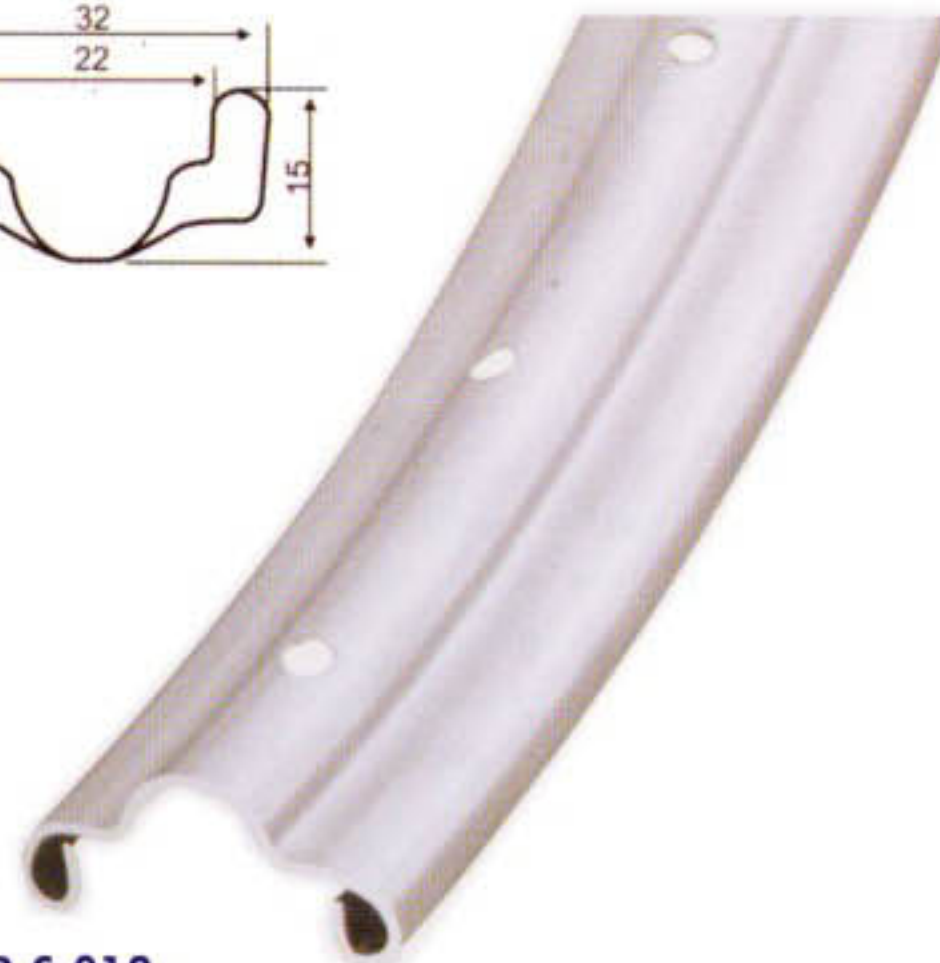
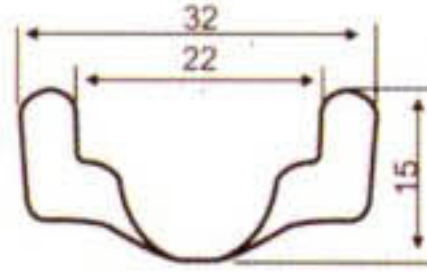

GR-S-012
STEEL RIM
 Sizes : 24" - 26" x 1-3/8
 Spoke Holes : 28H/36H
 Finish : CP or ED

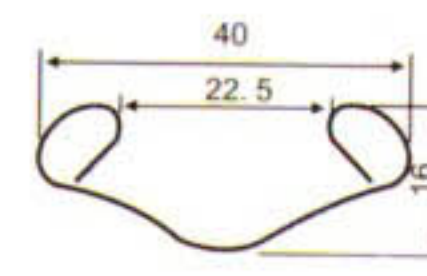

GR-S-015
STEEL RIM
 Sizes : 20"-28" x 1-1/2 (422-650 x 22.5mm)
 Spoke Holes : 16H/36H
 Finish : CP or ED

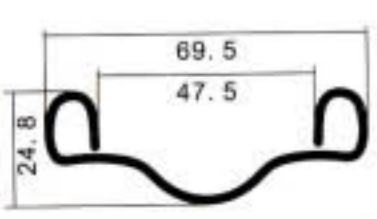

GR-S-019
STEEL RIM
 Sizes : 18 x 3.00.
 Spoke holes : with dimple 36H
 Finish : CP or ED

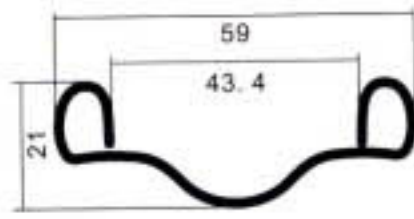

GR-S-020
STEEL RIM
 Sizes : 17 x 2.75 or 18 x 2.75
 Spoke holes : with dimple 36H
 Finish : CP or ED

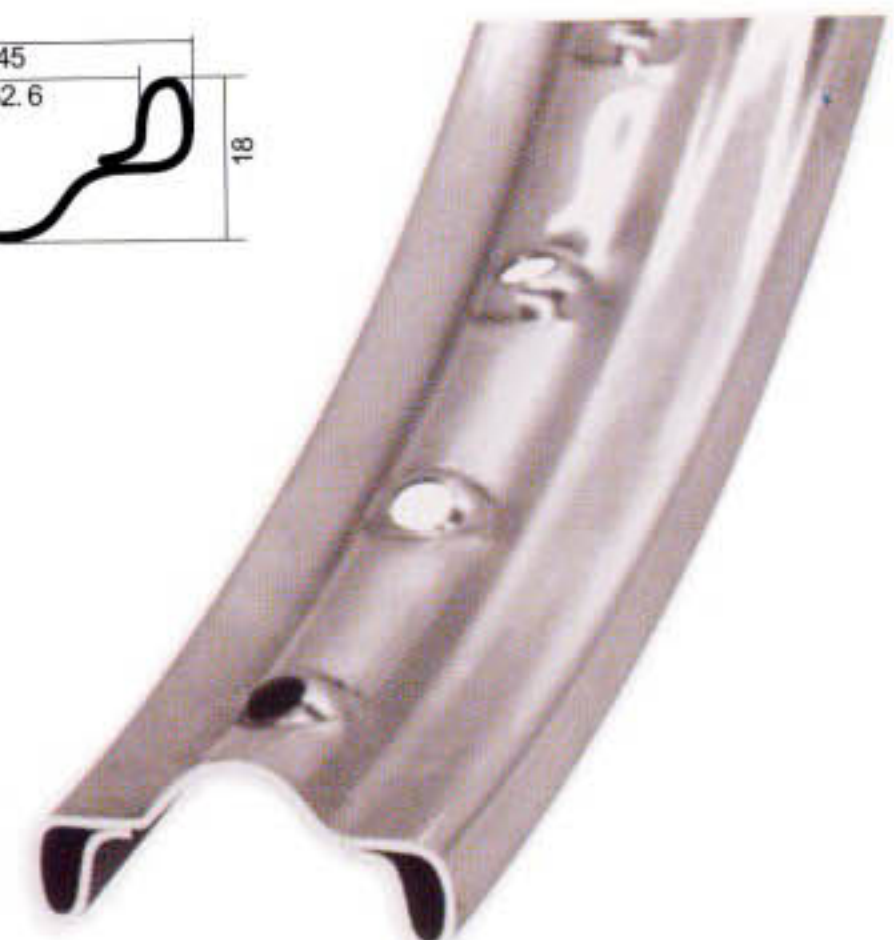
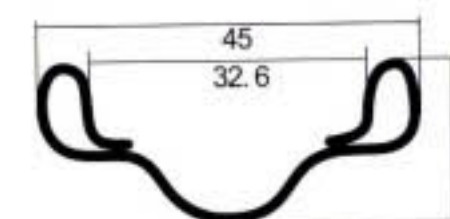

GR-S-022
STEEL TRICICLO RIM
 Sizes : 26 x 2.00/ 26 x 2.125/ 20 x 2.125
 Spoke holes : with dimple 36H
 Finish : CP or ED

RIM

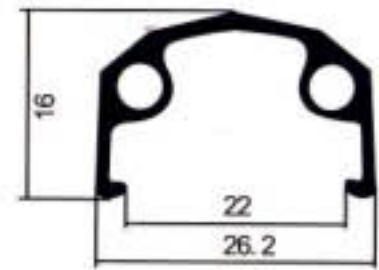
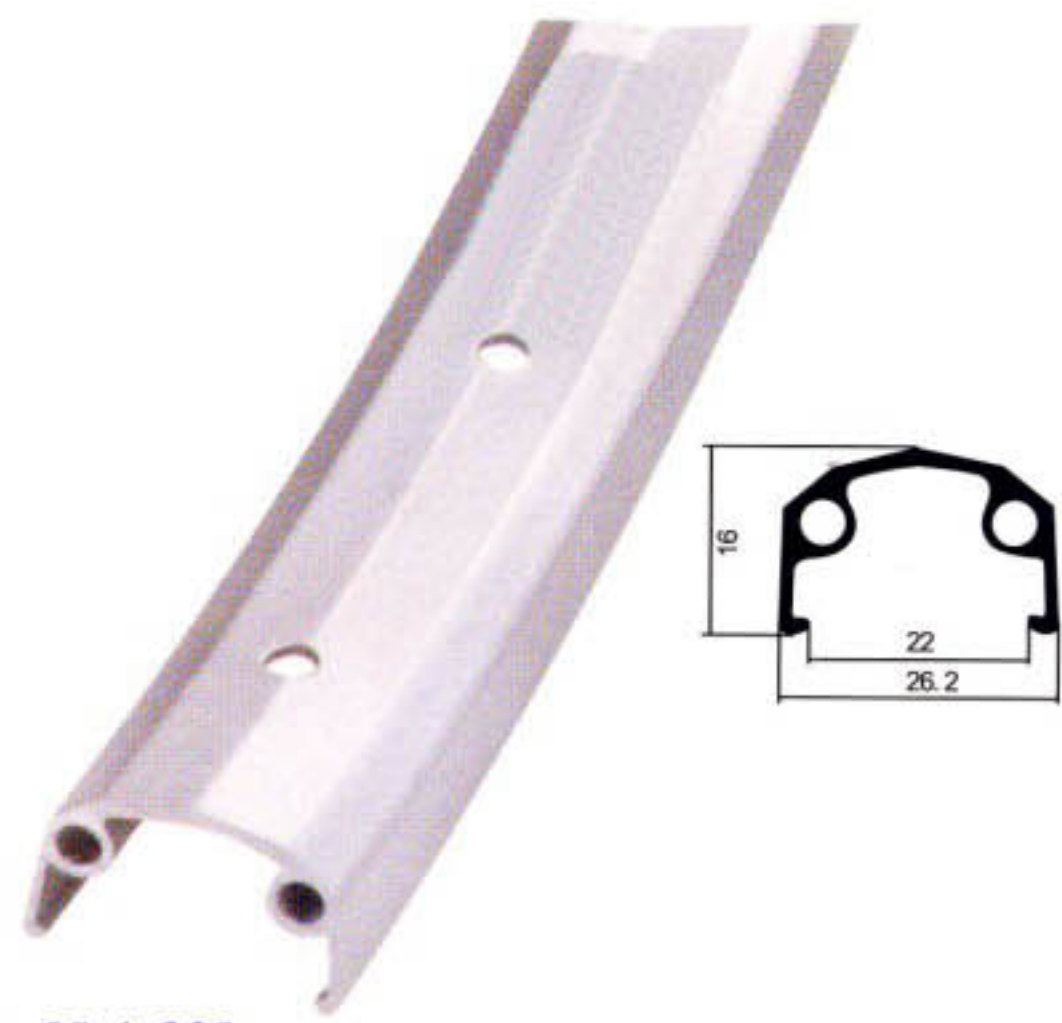

GR-A-002
ALLOY RIM
 Sizes : 22/24/26 x 1.3/8,
 16/18/20/22/24/26 x 1.75.
 Spoke Holes : 20/28/36H
 Finish : Polishing or oxidation

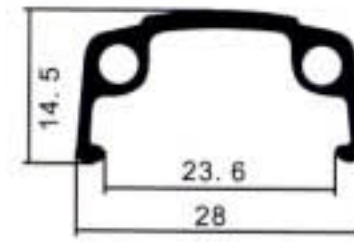

GR-A-006
ALLOY RIM
 Sizes : 22/24/26 x 1.3/8,
 16/18/20/22/24/26 x 1.75, 27 x 1-1/4
 Spoke Holes : 20/28/36H
 Finish : Polishing or oxidation

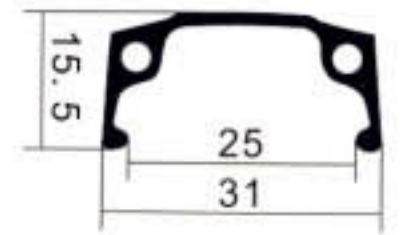

GR-A-007
ALLOY RIM
 Sizes : 212-26" x 1.75
 Spoke Holes : 16/20/28/32/36H
 Finish : Polishing or oxidation

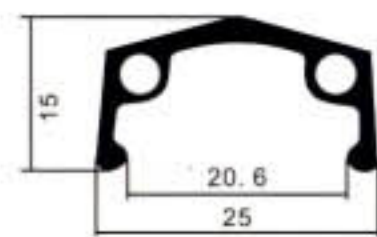

GR-A-012
ALLOY RIM
 Sizes : 22/24/26 x 1.3/8,
 16/18/20/22/24/26 x 1.75
 Spoke Holes : 20/28/36H
 Finish : Polishing or oxidation

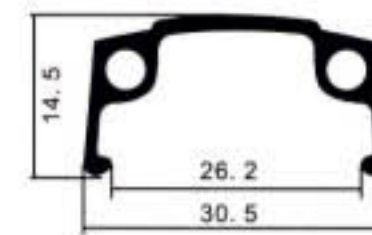

GR-A-013
ALLOY RIM
 Sizes : 22/24/26 x 1.3/8,
 16/18/20/22/24/26 x 1.75
 Spoke Holes : 20/28/36H
 Finish : Polishing or oxidation

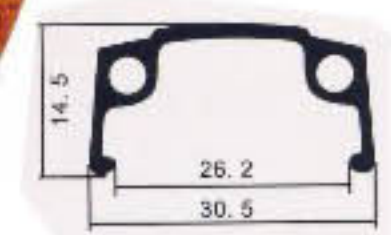

GR-A-014
ALLOY RIM
 Sizes : 22/24/26 x 1.3/8,
 16/18/20/22/24/26 x 1.75
 Spoke Holes : 20/28/36H
 Finish : Polishing or oxidation

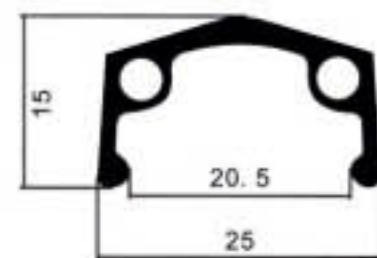
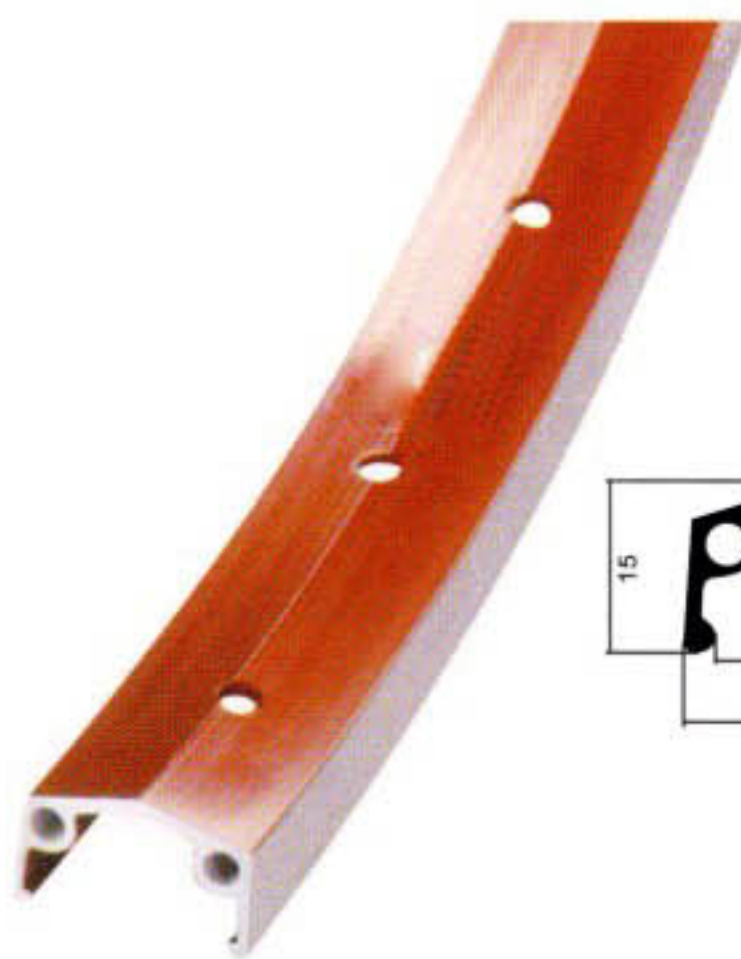

GR-A-015
ALLOY RIM
 Sizes : 22/24/26 x 1.3/8,
 16/18/20/22/24/26 x 1.75, 2 x 1-1/4
 Spoke Holes : 20/28/36H
 Finish : Polishing or oxidation

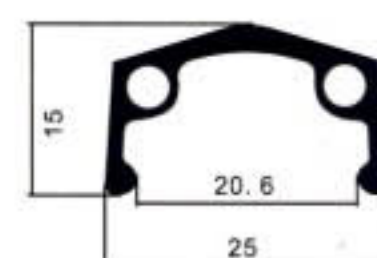
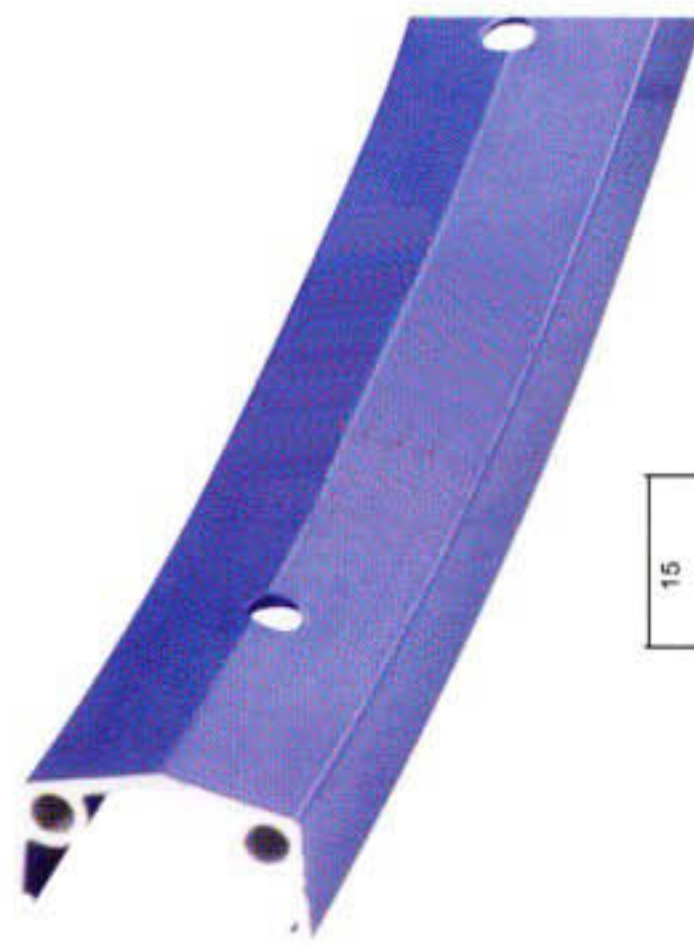

GR-A-016
ALLOY RIM
 Sizes : 22/24/26 x 1.3/8,
 16/18/20/22/24/26 x 1.75, 2 x 1-1/4
 Spoke Holes : 20/28/36H
 Finish : Polishing or oxidation

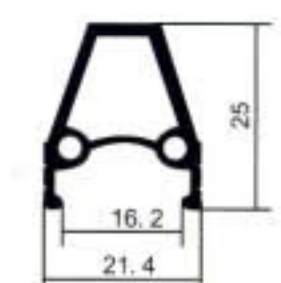

GR-A-022
ALLOY RIM
 Sizes : 22/24/26 x 1.3/8,
 16/18/20/22/24/26 x 1.75
 Spoke Holes : 20/24/32/36H
 Finish : Painting with CNC side



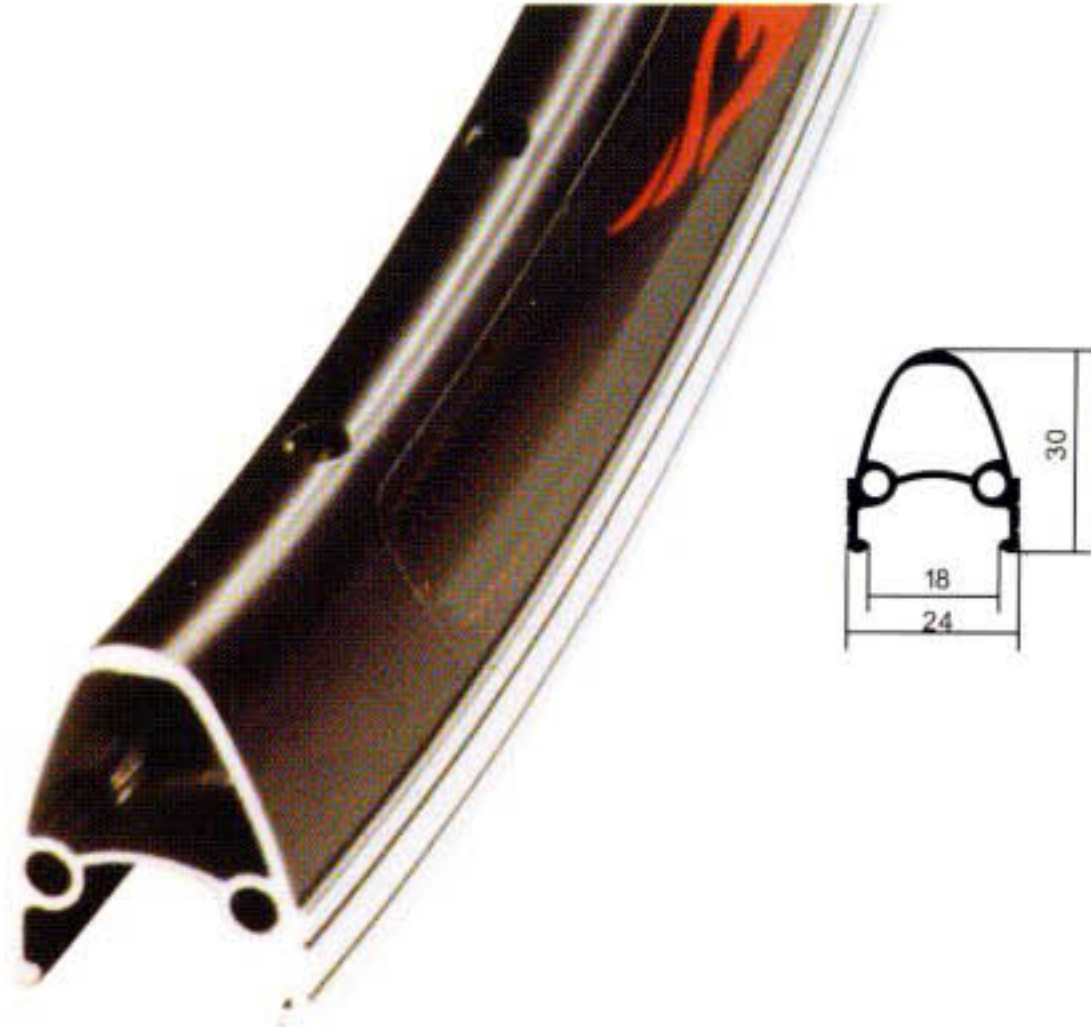

GR-A-024
ALLOY RIM
 Sizes : 20-26" x 1.75,
 22-26" x 1-3/8, 27" x 1-1/4
 Spoke Holes : 20/24/32/36H
 Finish : Painting with CNC side

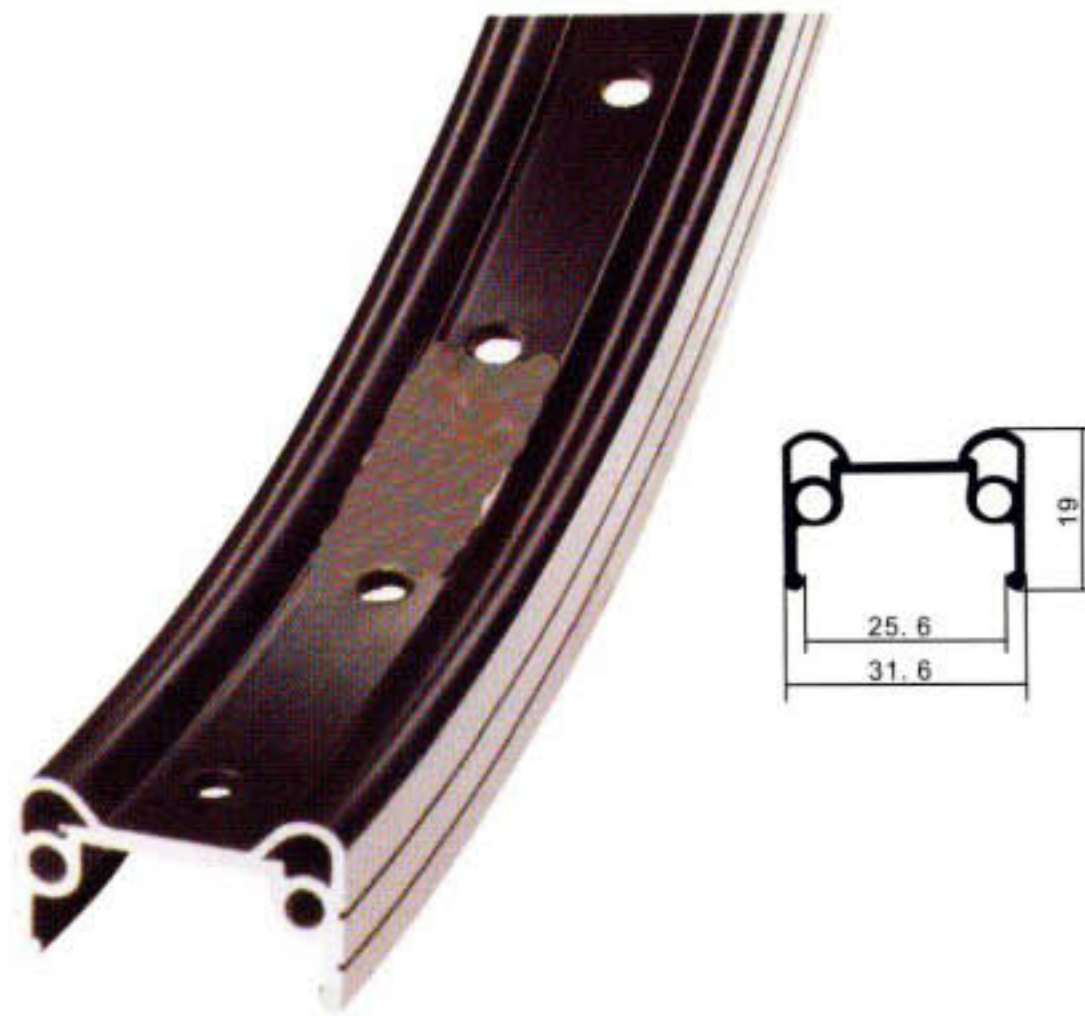

GR-A-028
ALLOY RIM
 Sizes : 16-24" x 1.75
 Spoke Holes : 36/48/68H
 Finish : Painting with CNC side



GR-A-S13H43
ALLOY RIM
 Sizes : 26 x 1.00 - 1.5 (650C and 700C)
 Spoke Holes : 32H/36H
 Finish : Painting

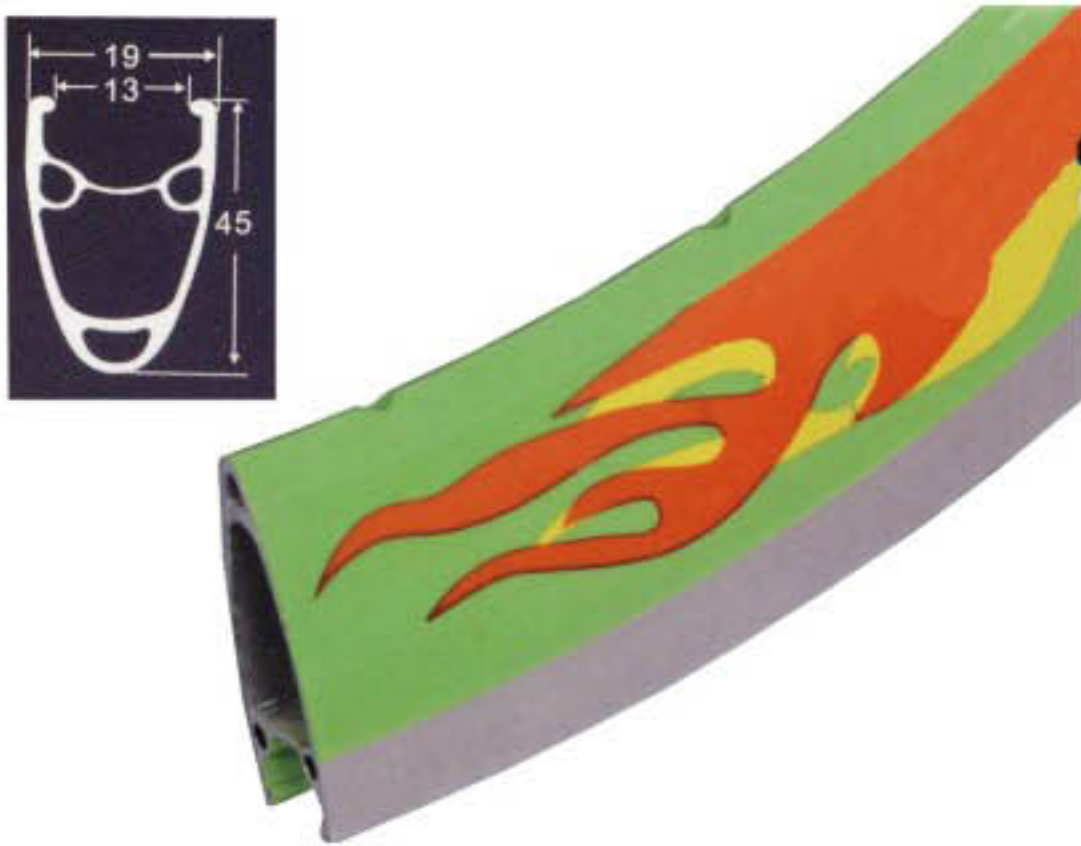

GR-A-S13H45
ALLOY RIM
 Sizes : 26 x 1.00 - 1.5 (650C and 700C)
 Spoke Holes : 32H/36H
 Finish : Painting

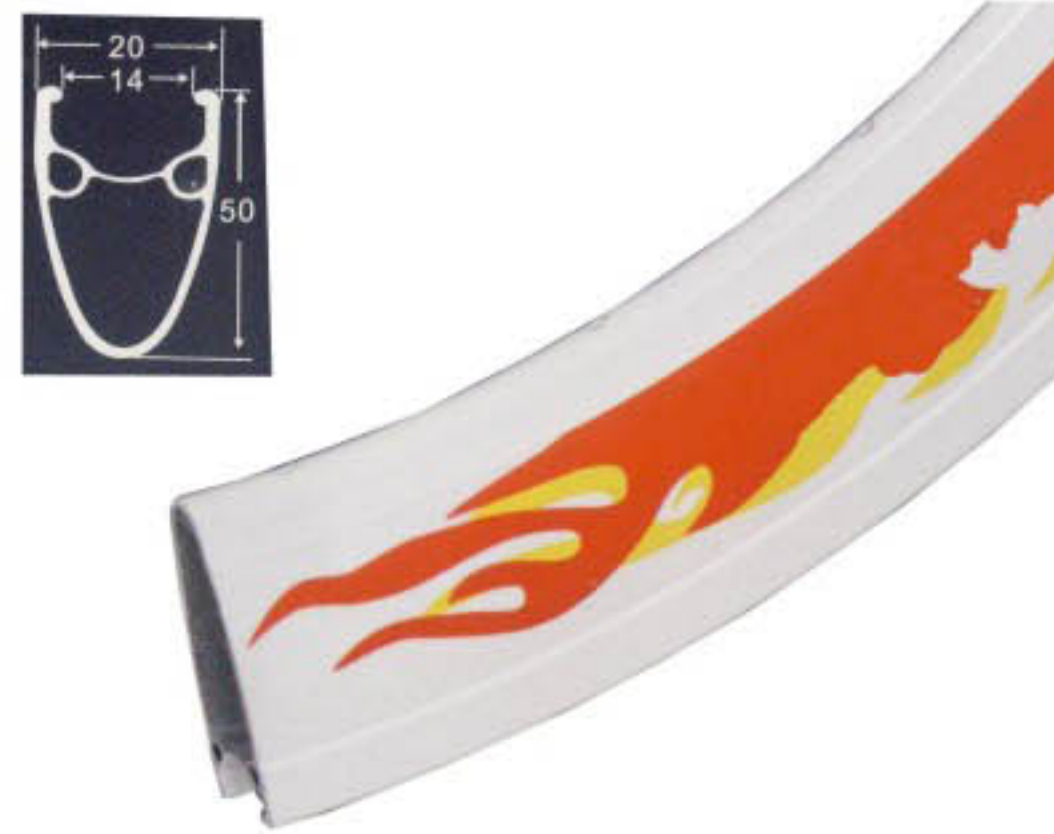

GR-A-S14H50
ALLOY RIM
 Sizes : 700C
 Spoke Holes : 32H/36H
 Finish : Painting



GR-A-S14H60
ALLOY RIM
 Sizes : 700C
 Spoke Holes : 32H/36H
 Finish : Painting



GR-A-S16
ALLOY RIM
 Sizes : 20-26" x 1.5. 700C
 Spoke Holes : 28/32/36
 Finish : Painting



GR-A-S16G
ALLOY RIM
 Sizes : 20-26" x 1.75-1.95. 700C, 27 x 1-1/4
 Spoke Holes : 28/32/36
 Finish : Painting



GR-S-002
STEEL RIM
 Sizes : 12-26" x 1.5-1.95
 Spoke Holes : 16/20/28/32/36H
 Finish : CP or ED

PEDAL



GPN-B113
CHILDREN NYLON FOOT PEDAL
Size : 90mm x 55mm
Finish : Black/ Colors



GPN-B114
CHILDREN NYLON FOOT PEDAL
Size : 90mm x 55mm
Finish : Black/ Colors



GPN-B101
MTB NYLON FOOT PEDAL
Size : 114mm x 82mm
Finish : Black/ Colors



GPN-B106
MTB NYLON FOOT PEDAL
Size : 113mm x 90mm
Finish : Black/ Colors



GPN-B115
CHILDREN NYLON FOOT PEDAL
Size : 94mm x 57mm
Finish : Black/ Colors



GPN-B116
CHILDREN NYLON FOOT PEDAL
Size : 105mm x 60mm
Finish : Black/ Colors

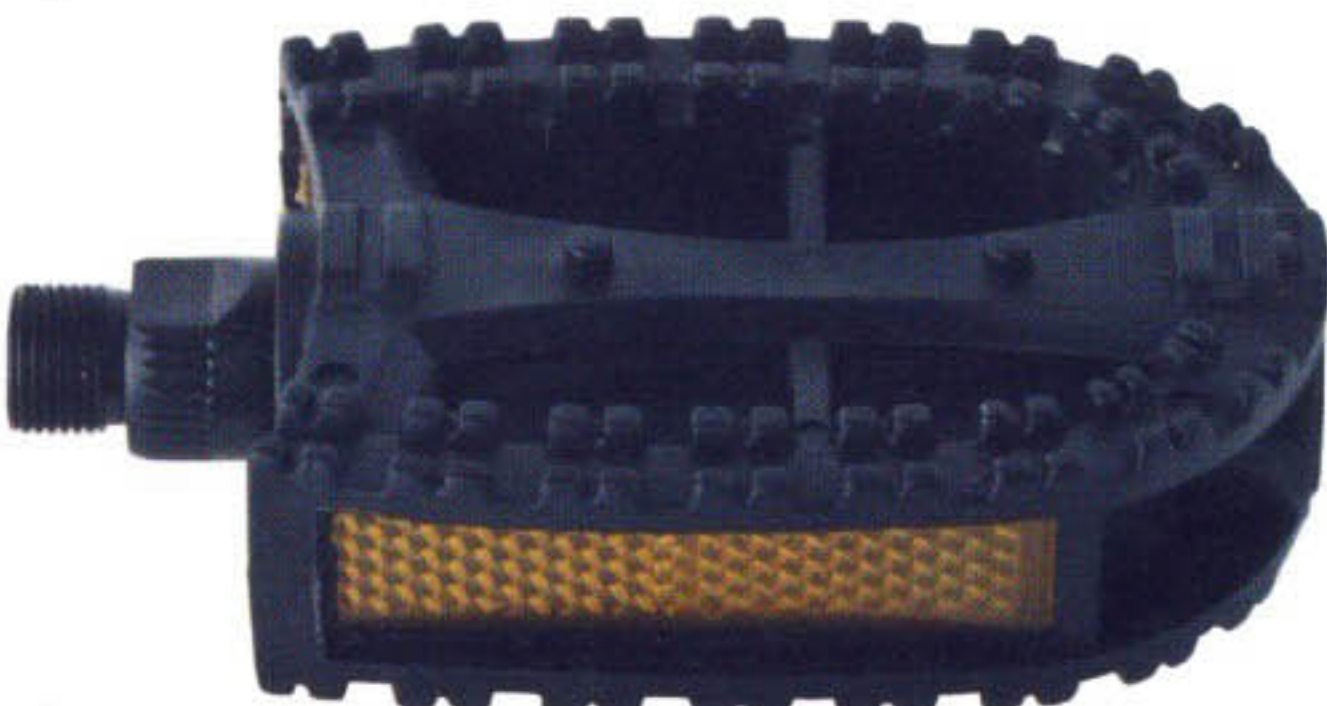

GPN-B118
CHILDREN NYLON FOOT PEDAL
Size : 110mm x 65mm
Finish : Black/ Colors



GPN-B138
MTB NYLON FOOT PEDAL
Size : 112mm x 80mm
Finish : Black/ Colors



PEDAL

GURSAM



GPN-B134
MTB NYLON FOOT PEDAL
Size : 118mm x 73mm
Finish : Black/ Colors



GPN-B131
MTB NYLON FOOT PEDAL
Size : 113mm x 90mm
Finish : Black/ Colors



GPN-B107
MTB NYLON FOOT PEDAL
Size : 117mm x 95mm
Finish : Black/ Colors



GPN-B103
LADY NYLON FOOT PEDAL
Size : 110mm x 73mm
Finish : Black/ Colors



GPN-B139
MTB NYLON FOOT PEDAL
Size : 115mm x 73mm
Finish : Black/ Colors



GPN-B145
MTB NYLON FOOT PEDAL
Size : 117mm x 79mm
Finish : Double Color



GPN-B170
MTB NYLON FOOT PEDAL
Size : 113mm x 69mm
Finish : Double Color



GPR-B215
RUBBER STEEL PEDAL
Size : 120mm x 72mm
Finish : To Order

PEDAL

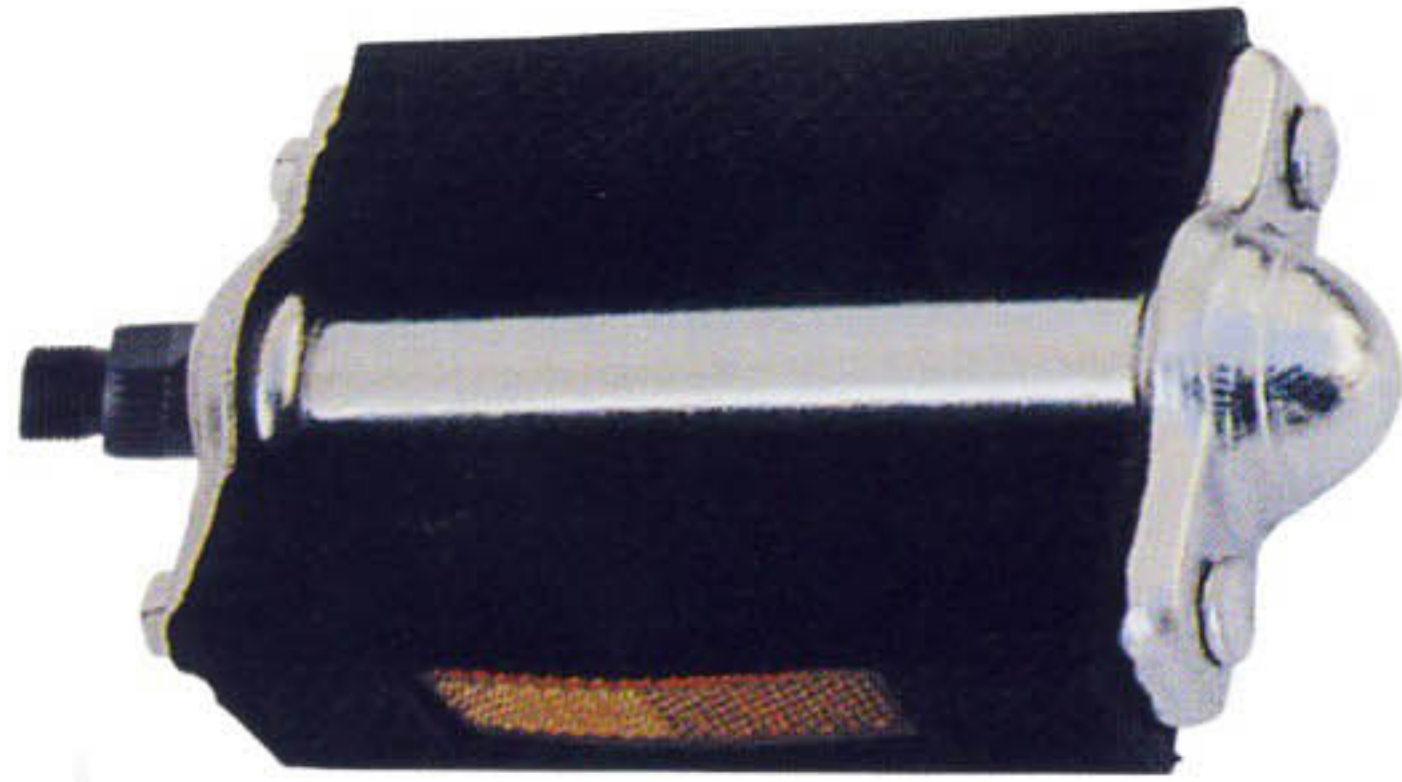

GPR-B216
RUBBER STEEL PEDAL
Size : 125mm x 65mm
Finish : To Order



GPN-B182
ROAD WITH TOE CLIP MOUNTABLE
Plastic Body, alloy/steel cage
Size : 104 x 65.2 x 27.6mm
Finish : To Order



GPM-201
PEDAL FOR MOTORCYCLE
Finish : To Order



GPA-V14
PEDAL ALUMINIUM ALLOY
Finish : Silver/ Colors



GPA-V07
PEDAL ALUMINIUM ALLOY
Finish : Silver/ Colors



GPA-V18
PEDAL ALUMINIUM ALLOY
Finish : Silver/ Colors



GPA-V11
PEDAL ALUMINIUM ALLOY
Finish : Silver/ Colors



GPA-V24
PEDAL ALUMINIUM ALLOY
Finish : Silver/ Colors



SADDLE

CURSAM



GWL-603
SADDLE BLACK
MTB Economic type without PU Cushion
255mmx155mm (With or without seat clips)



GWL-602
SADDLE BLACK
MTB type with PU Cushion
270mmx180mm(With or without seat clips)



GWL-2601P
SADDLE BLACK
Smarter type with springs
270mmx145mm with seat clip



GWL-136
SADDLE BLACK
BRASILIAN TYPE
250mmx205mm with springs



GWL-201A
SADDLE BLACK



GWL-5700
SADDLE HIGH END
Size : 285mmx140mm
Color : black/grey, White/red

SADDLE



GWL-5701

SADDLE HIGH END

Size : 285mmx140mm

Color : Black/Grey, White/Red/Grey



GWL-5706

SADDLE HIGH END

Size : 270mmx130mm

Color : Black/Grey, White/Grey



GWL-5702

SADDLE HIGH END

Size : 285mmx140mm

Color : Black/Grey, White/Grey



GWL-5707

SADDLE HIGH END

Size : 270mmx132mm

Color : Black/Red, Black/Green



GWL-5705

SADDLE HIGH END

Size : 270mmx132mm

Color : Black/Grey, White/Black



GWL-5711

SADDLE HIGH END

Size : 265mmx130mm

Color : Black/Grey/Red, White/Black/Red



SADDLE

CURSAM



GWL-5723
SADDLE HIGH END
Size : 280mmx135mm
Color : White/Grey/Blue, White/Black/Red



GWL-5742
SADDLE HIGH END
Size : 270mmx132mm
Color : Black/Red/White



GWL-5730
SADDLE HIGH END
Size : 270mmx130mm
Color : White/Grey/Red, White/Black/Red



GWL-5804
SADDLE KID
Size : 240mmx160mm
Color : Black with My Kid Marking



GWL-5734
SADDLE HIGH END
Size : 270mmx132mm
Color : Black



GWL-5806
SADDLE MKY, KID
Size : 245mmx150mm
Color : To Order

SADDLE



GWL-5903
SADDLE HIGH END MTB
Size : 260mmx150mm
Color : To Order



GWL-6005-61
SADDLE HIGH END
For Tourister



GWL-5911
SADDLE HIGH END "NIKE"
Size : 260mmx150mm
Color : To Order



GWL-6600
SADDLE HIGH END Heavy Duty
For Tourister



GWL-5922
SADDLE HIGH END (Double Grip)
Size : 270mmx162mm
Color : Black/Blue/Grey



GWL-1105-3
SADDLE KID
210mmx140mm
Color as per Catalogue, "STAR" Type



SEAT CLAMP

CURSAM

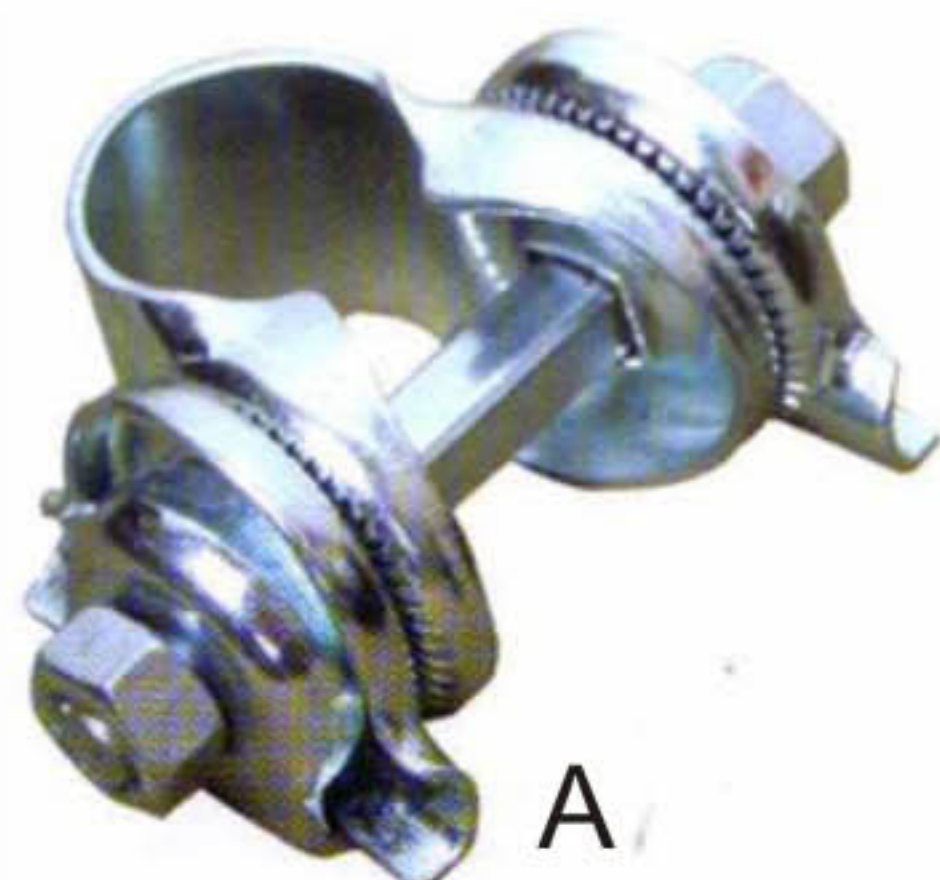

A

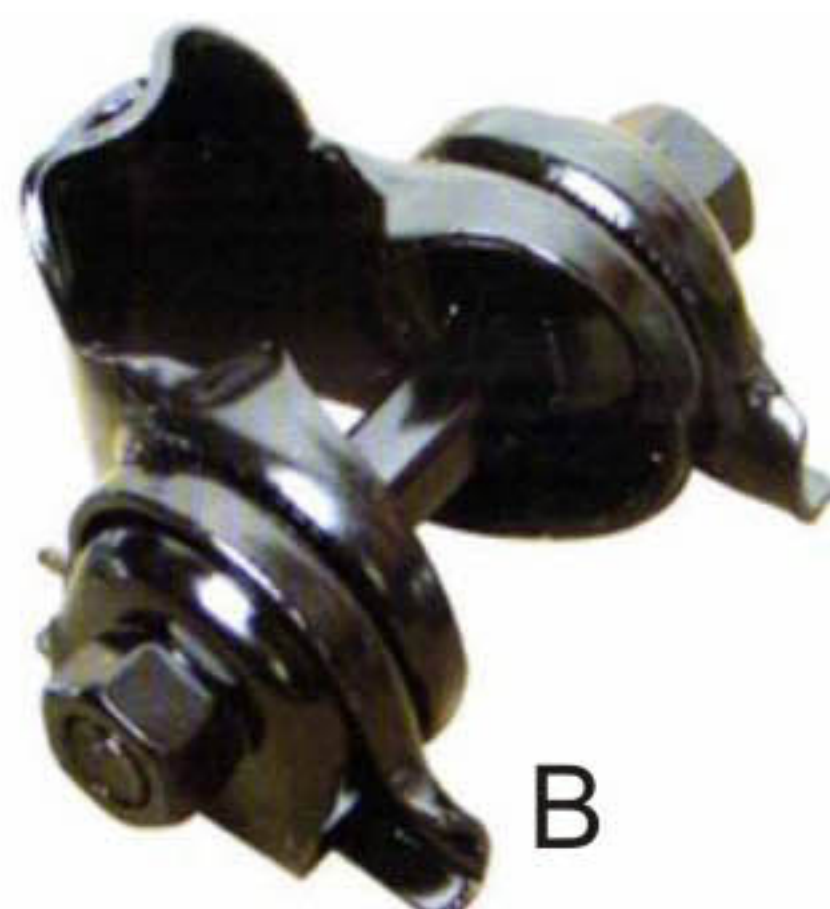

B



C



GHX-Y05-01
ALLOY SEAT CLAMP WITH QUICK RELEASE
31.8mm, Colour self and anodised colour



GHX-Y05-03
ALLOY SEAT CLAMP WITH QUICK RELEASE
25.4mm, Colour self and anodised colour



GHX-Y04-06
ALLOY HUB QUICK RELEASE M5
Colour self and anodised colour,
size to order for front hubs and rear hubs

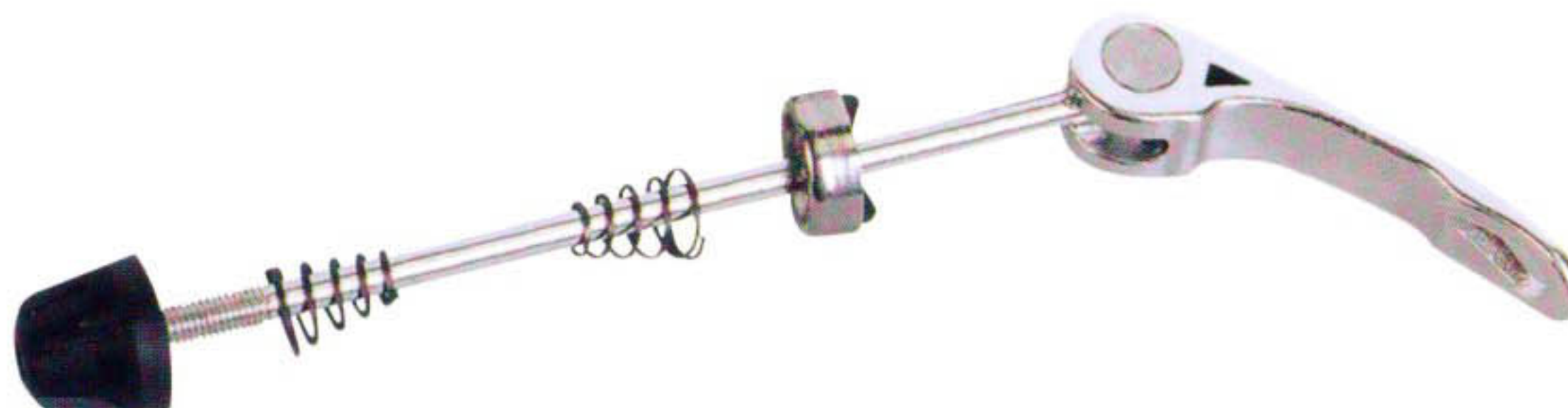

GHX-Y04-07
ALLOY HUB QUICK RELEASE M5
Colour self and anodised colour,
size to order for front hubs and rear hubs

PUMPS



GJS 8603A
Frame Pump
Plastic 22x400mm
Finish : Coloured



GJS 8601
Frame Pump
Steel 22x400mm
Finish : CP, Coloured



GJS 8608
Mini Pump
Plastic, 21x240mm
Finish : Coloured



GJS 8804B
Hand Pump
Steel 38x450mm
Finish : CP, Coloured



GJS 8806A
Hand Pump
Steel 38x500mm
Finish : CP, Coloured



GJS 8817
Hand Pump
Alloy 38x580mm
Finish : Coloured



GJS 8901E
Hand Pump
Alloy 38x530mm
Finish : Coloured



GJS 8921A
Hand Pump
Alloy 38x500mm
Finish : Coloured



GJS 8702C
Foot Pump
Steel 55x120mm
Finish : Coloured



GJS 8701A
Foot Pump
Steel 55x120mm
Finish : Coloured



GJS 9806
Foot Pump
Steel 55x120mm
Finish : Coloured



GJS 8503
Electric Pump
12V, Max 250PSI
Finish : Coloured



FORKS

GURSAM



GJSFK-01
SUSPENTION FORK
Size : 26"/24"/20"
PRESSED STEEL CROWN
25.4 X 1.8/1.6T, 31.8MM



GJSFK-02
SUSPENTION FORK
Size : 26"/24"/20"
PRESSED STEEL CROWN
25.4 X 1.6T, 31.8MM



GJSFK-03
SUSPENTION FORK
Size : 26"/24"/20"
FORGED 6061 T6 AL CROWN
38.1X2.0T, 31.8MM



GJSFK-04
SUSPENTION FORK
Size : 26"/24"/20"
FORGED 6061 T6 AL CROWN
25.4 X 1.8T, 31.8MM



GJSFK-05
SUSPENTION FORK
Size : 26"/24"/20"
FORGED 6061 T6 AL CROWN
31.8 X 1.4T, 50.8MM



GJSFK-06
SUSPENTION FORK
Size : 26"/24"/20"
FORGED 6061 T6 AL CROWN
25.4 X 1.8T, 34.9/38.1MM



GJSFK-07
STEEL FORK
Size : 26"/24"/20"
STEM ID : 22.2X25.4, 25.4/28.6/31.8
Finish : CP/BED/COLOURS



GJSFK-08
STEEL FORK
Size : 26"/24"/20"
STEM ID : 22.2X25.4, 25.4/28.6/31.8
Finish : CP/BED/COLOURS



GJSFK-09
STEEL FORK
Size : 26"/24"/20"
STEM ID : 22.2X25.4, 25.4/28.6/31.8
Finish : CP/BED/COLOURS



GJSFK-10
STEEL FORK
Size : 26"/24"/20"
STEM ID : 22.2X25.4, 28.6/31.8
Finish : CP/BED/COLOURS



GJSFK-11
STEEL FORK
Size : 26"/24"/20"
STEM ID : 22.2X25.4, 25.4/28.6/31.8
Finish : CP/BED/COLOURS



GJSFK-12
STEEL FORK
Size : 26"/27"
STEM ID : 22.2X25.4, 22.2
Finish : CP/BED/COLOURS



GJSFK-13
STEEL FORK
Size : 26"/24"/20"
STEM ID : 22.2X25.4, 25.4/28.6/31.8
Finish : CP/BED/COLOURS



GJSFK-14
STEEL FORK
Size : 26"/24"/20"
STEM ID : 22.2X25.4, 25.4/28.6/31.8
Finish : CP/BED/COLOURS



GJSFK-15
STEEL FORK
Size : 26"/24"/20"
STEM ID : 22.2X25.4, 25.4/28.6/31.8
Finish : CP/BED/COLOURS



GJSFK-16
STEEL FORK
Size : 26"/24"/20"
STEM ID : 22.2X25.4, 25.4/28.6/31.8
Finish : CP/BED/COLOURS

FRAMES



GEFM-011
MTB SUSPENSION FRAME 20"
 Material : Alloy
 Size : 30x34x120mm



GEFM-012
MTB SUSPENSION FRAME 26"
 Material : Alloy
 Size : 30x34x120mm



GJSFP-01
HEAD TUBE
 Dia : 34MM X 30MM



GJSFP-02
BOTTOM BRACKET SHEET
 For OPC, With or Without Threads
 Size : 56.5 X 51.5 X 68MM
 56.5 X 51.5 X 68MM



GJSFP-03
BOTTOM BRACKET SHEET
 Size : 40 X 34 X 68MM

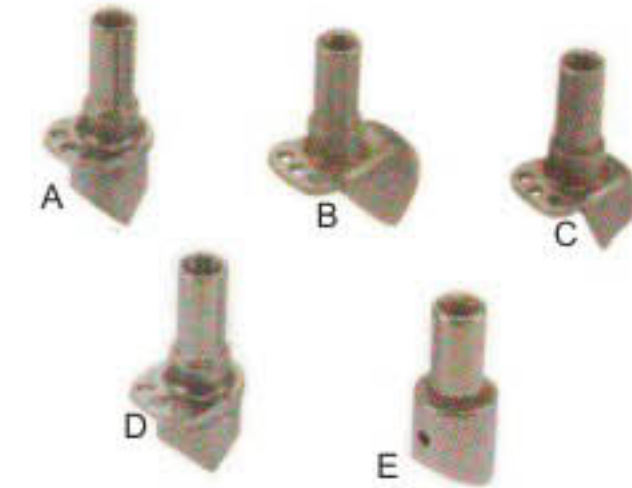

GJSFP-06
PIVOT



GJSFP-04
FORK HEAD STEM
 Size : BC1" X 24T, 1-1/8" X 26T,
 Dia : 25.4 X 22.2, 25.4 X 21.15



GJSFP-05
FORK HEAD STEM
 Size : BC1" X 24T, 1-1/8" X 26T,
 Dia : 25.4 X 22.2, 28.6 X 25.4

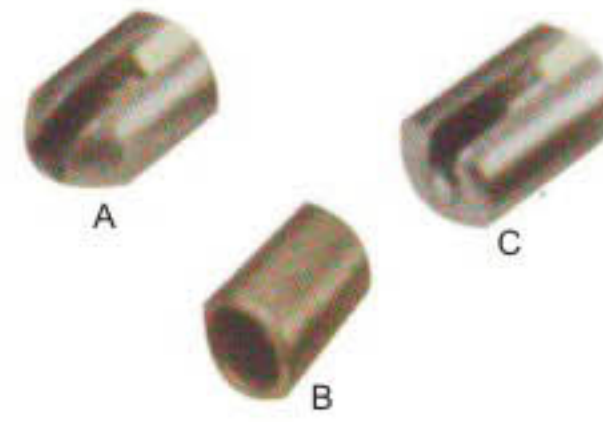

GJSFP-07
CABLE STOPPER



GJSST-06
COTTERED PIN



GJSFP-10
PRESS END (FRAME)

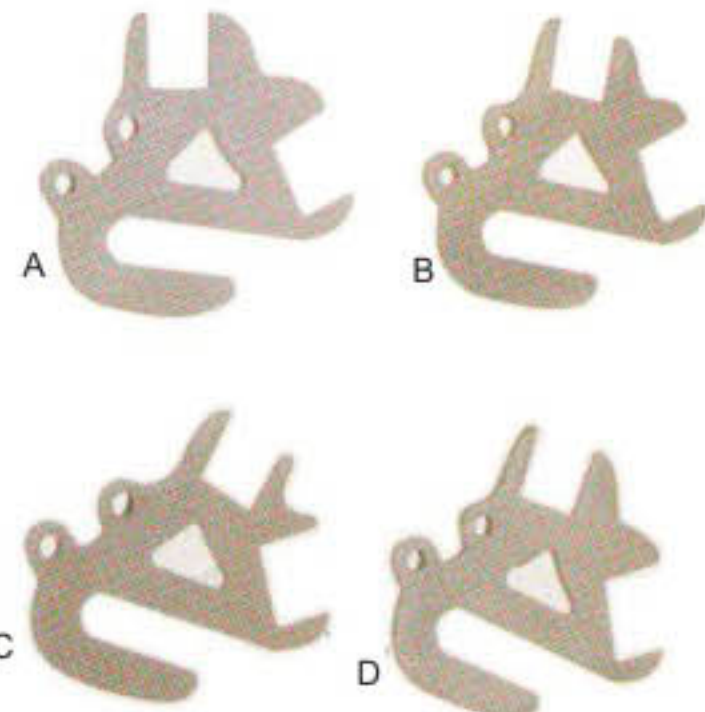

GJSFP-08
PRESS END (FRAME)



GJSFP-09
PRESS END (FRAME)
PRESS END (FORK)



LOCKS



GI-22101
SMALL ROUND HEAD CABLE LOCK
Length : ϕ 8 x 600mm, ϕ 10 x 650mm
Size : 61x30.5x22.5cm, 45.5x26.5x45cm



GI-22205
IRON HEAD CABLE LOCK
Length : ϕ 30x15x800mm, ϕ 30x20x1000mm
Size : 45.5x22x36cm, 40x39.5x30cm



GI-22201
IRON HEAD CABLE LOCK
Length : ϕ 25x15x800mm, ϕ 25x15x1000mm, 25x15x1200mm
Size : 56x26.5x32cm, 59.5x29x34cm, 59.5x29x34cm



GI-22210
RESETTABLE COMBINATION CABLE LOCK
Length : ϕ 10x650mm, ϕ 12x650mm, ϕ 15x650mm
Size : 41x18x40cm, 47.5x31.5cm, 48.5x32.5x34cm



GI-22203
3-DIGIT COMBINATION LOCK
Length : ϕ 5 x 550mm, ϕ 6 x 650mm, ϕ 8 x 550mm
Size : 50x26x36.5cm, 61x27.5x28cm, 50x26x26.5cm



GI-23104
JOINT LOCK
Length : ϕ 30x25x1000mm, ϕ 30x25x1200mm, ϕ 30x25x1500mm
Size : 53x25x17.5cm, 58x28x17.5cm, 61x30.5x20cm



LOCKS



GI-23105
JOINT LOCK
 Length : ϕ 32.5x25x1000mm, ϕ 32.5x25x1200mm
 Size : 58x28x33cm, 58x28x27.5cm



GI-27103
PERSONAL 4-DIGIT CIPHER CODE CYCLE CABLE LOCK
 Length : ϕ 10x1000mm, ϕ 10x1200mm, 10x1500mm, 10x1800mm
 Size : 47x37x28.5cm, 49x40x28.5cm, 52x40x28.5cm, 62x40x28.5cm



GI-25103
ROUND CHAIN LOCK
 Length : ϕ 8x900mm, ϕ 8x120mm
 Size : 39x38x17.5cm, 41x40x8.5cm



GI-27106
3-DIGIT COMBINATION CYCLE CABLE LOCK
 Length : ϕ 8x1200mm, ϕ 12x1200mm
 Size : 63.5x3.x25cm, 39x29.5x36cm



GI-27101
SMALL SQUARE HEAD CYCLE CABLE LOCK
 Length : ϕ 6x1000mm, ϕ 8x1500mm
 Size : 46.5x41x27cm, 44x21x30cm



GI-27110
4-DIGIT COMBINATION CYCLE CABLE LOCK
 Length : ϕ 6x1500mm, ϕ 6x1500mm
 Size : 47x33.5x30cm, 43x39.5x23cm



GI-27102
SMALL ROUND HEAD CYCLE CABLE LOCK
 Length : ϕ 6x1000mm, ϕ 6x1500mm
 Size : 43x38x31.5cm, 45x40x34.5cm



GI-27107
BIG ROUND HEAD CYCLE CABLE LOCK
 Length : ϕ 8x1000mm, ϕ 10x1000mm, ϕ 12x1000mm
 Size : 52x28.5x20cm, 64x26x28cm, 64x27x30cm



GRIPS



GJSGR-01
GRIP
Size : ϕ 23x 110MM
Material : RUBBER + EVA



GJSGR-02
GRIP
Size : 125MM
Material : Soft PVC/TPR



GJSGR-03
GRIP
Size : ϕ 20 x 110MM
Material : RUBBER + EVA



GJSGR-04
GRIP
Size : ϕ 110MM/127MM
Material : RUBBER + EVA



GJSGR-05
GRIP
Size : ϕ 10 X 98MM/120MM
Material : RUBBER + EVA



GJSGR-06
GRIP
Size : ϕ 20 x 125MM
Material : RUBBER + EVA



GJSGR-07
GRIP
Size : ϕ 20 x 125MM
Material : RUBBER + EVA



GJSGR-08
GRIP
Size : ϕ 20 x 128MM
Material : RUBBER + EVA



GJSGR-09
GRIP
Size : ϕ 20 x 130MM
Material : RUBBER + EVA



GJSGR-10
GRIP
Size : ϕ 20 x 130MM
Material : RUBBER + EVA



GJSGR-11
GRIP
Size : ϕ 20 x 120MM
Material : RUBBER + EVA



GJSGR-12
GRIP
Size : ϕ 20 x 130MM
Material : RUBBER + EVA



GRIPS



GJSGR-14
GRIP
Size : ϕ 20x 125MM
Material : RUBBER + EVA



GJSGR-15
GRIP
Lenght : 115MM
Material : Soft PVC/TPR



GJSGR-16
GRIP
Lenght : 110MM
Material : Soft PVC/TPR

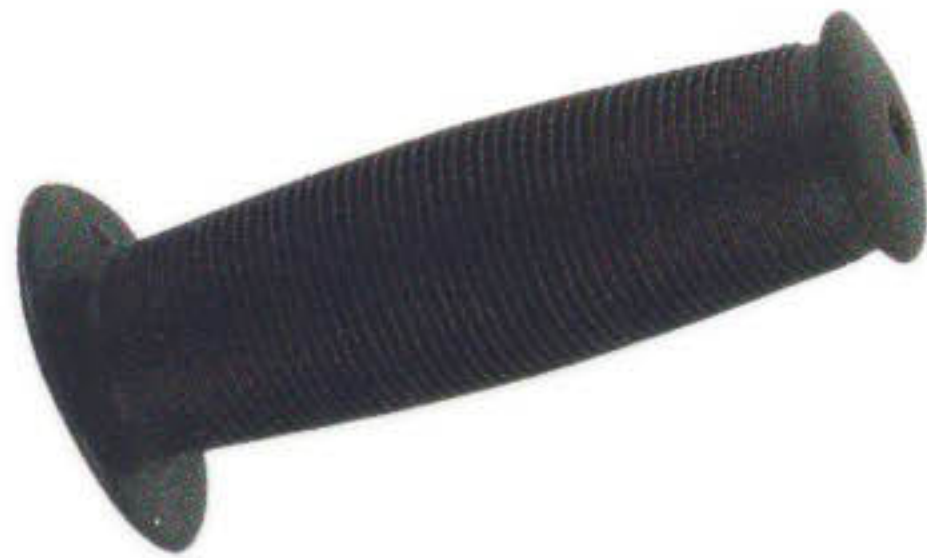

GJSGR-17
GRIP
Lenght : 105MM/110MM
Material : Soft PVC/TPR

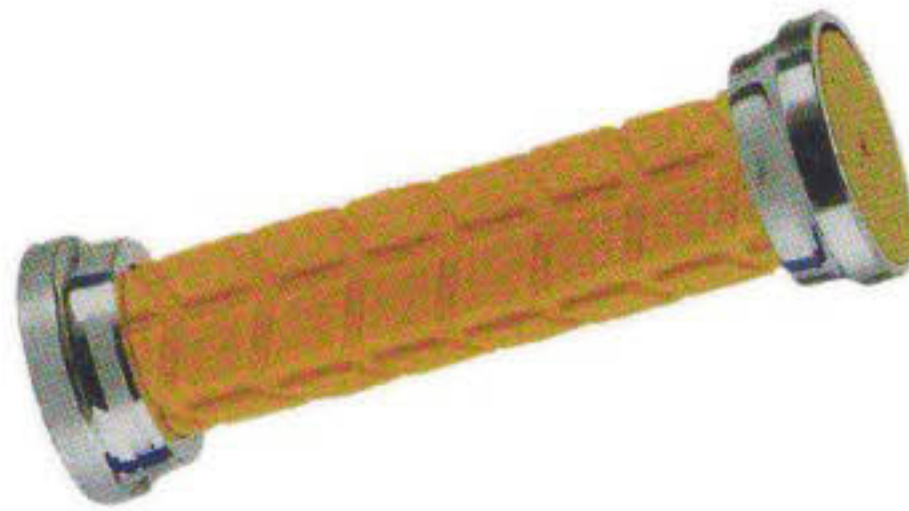

GJSGR-18
GRIP
Lenght : 125MM
Material : Soft PVC/TPR



GJSGR-19
GRIP
Lenght : 118MM
Material : Soft PVC/TPR



GJSGR-20
GRIP
Lenght : 108MM/118MM
Material : Soft PVC/TPR



GJSGR-21
GRIP
Lenght : 120MM
Material : Soft PVC/TPR



GJSGR-22
GRIP
Lenght : 98MM/128MM
Material : Soft PVC/TPR



GJSGR-23
GRIP
Lenght : 98MM/128MM
Material : Soft PVC/TPR



GJSGR-24
GRIP
Lenght : 120MM
Material : Soft PVC/TPR



GJSGR-25
GRIP
Size : ϕ 20 x 220MM(4PCS/SET)
Material : RUBBER + EVA



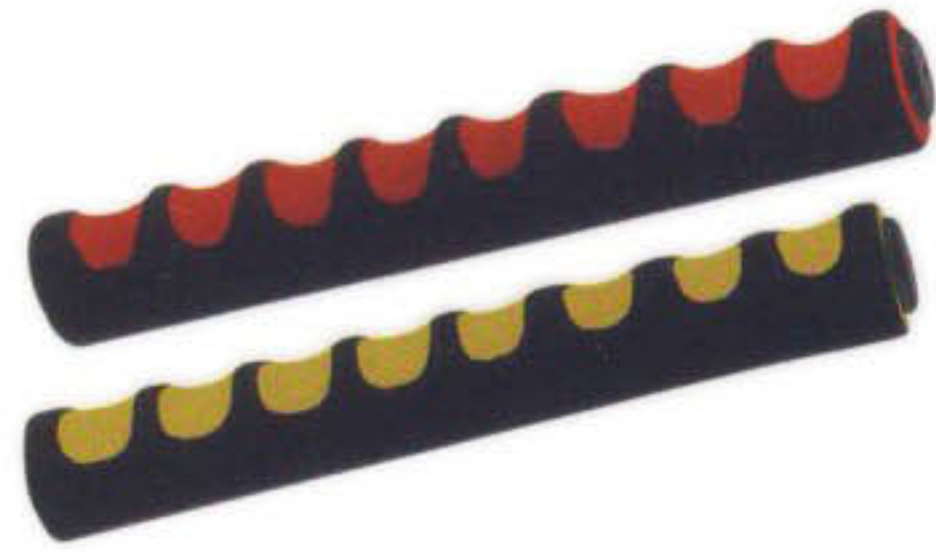

GJSGR-26
GRIP
Size : ϕ 20x220mm, 4pcs/set
Material : Eva with rubber ends



GJSGR-27
GRIP
Lenght : 20x220mm, 20x125mm 4pcs/set
Material : Eva with rubber ends



GJSGR-28
GRIP
Lenght : 110MM
Material : Soft PVC/TPR



GJSGR-29
GRIP
Lenght : 128MM
Material : TPR/Alloy



GJSGR-30
GRIP
Lenght : 128MM
Material : TPR/Alloy



GJSGR-31
GRIP
Lenght : 130MM
Material : TPR/Alloy



GJSGR-32
GRIP
Size : ϕ 10x100mm
Material : RUBBER + EVA



GJSGR-33
GRIP
Size : ϕ 20x 2220MM(4PCS/SET)
Material : RUBBER + EVA



GJSGR-34
GRIP
Size : ϕ 20x 215MM(4PCS/SET)
Material : RUBBER + EVA



MUDGUARDS

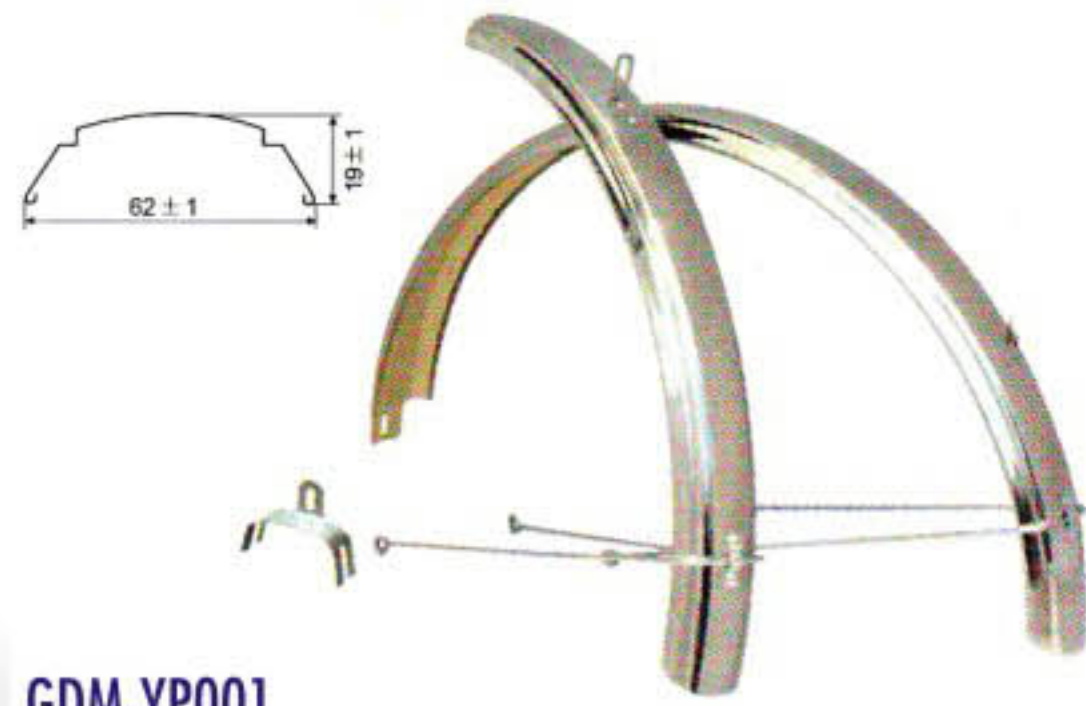

GDM-YP001
MUDGUARD
 Material : STEEL/STAINLESS/ALLOY
 Size : 20"/24"/26"X2.125
 Packing : 26": 76X46X32=50PRS 37.5/36.5

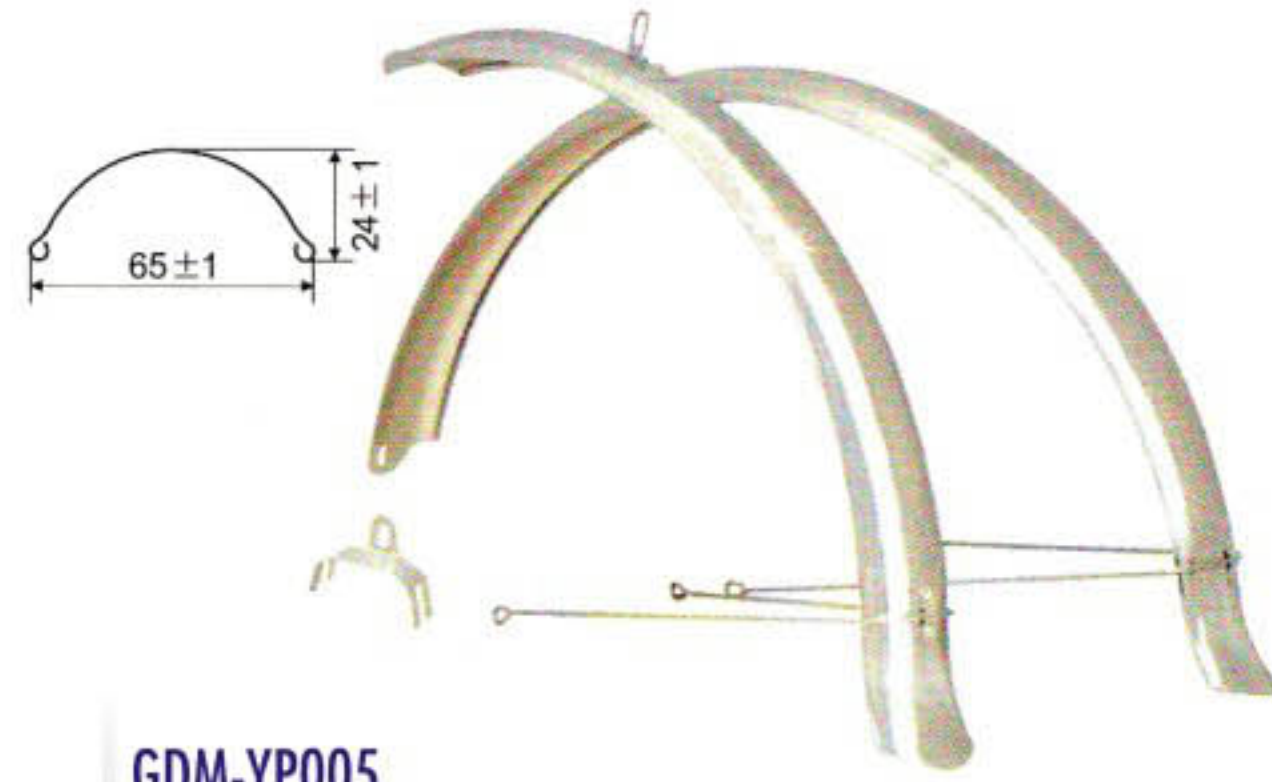

GDM-YP005
MUDGUARD
 Material : STEEL/STAINLESS
 Size : 1.95~2.125
 Packing : 26": 76X46X32=50PRS 37.5/36.5



GDM-YP060/YP058
MUDGUARD
 Material : STEEL/STAINLESS/ALLOY
 Size : 700C/20" BMX, MTB
 Packing :

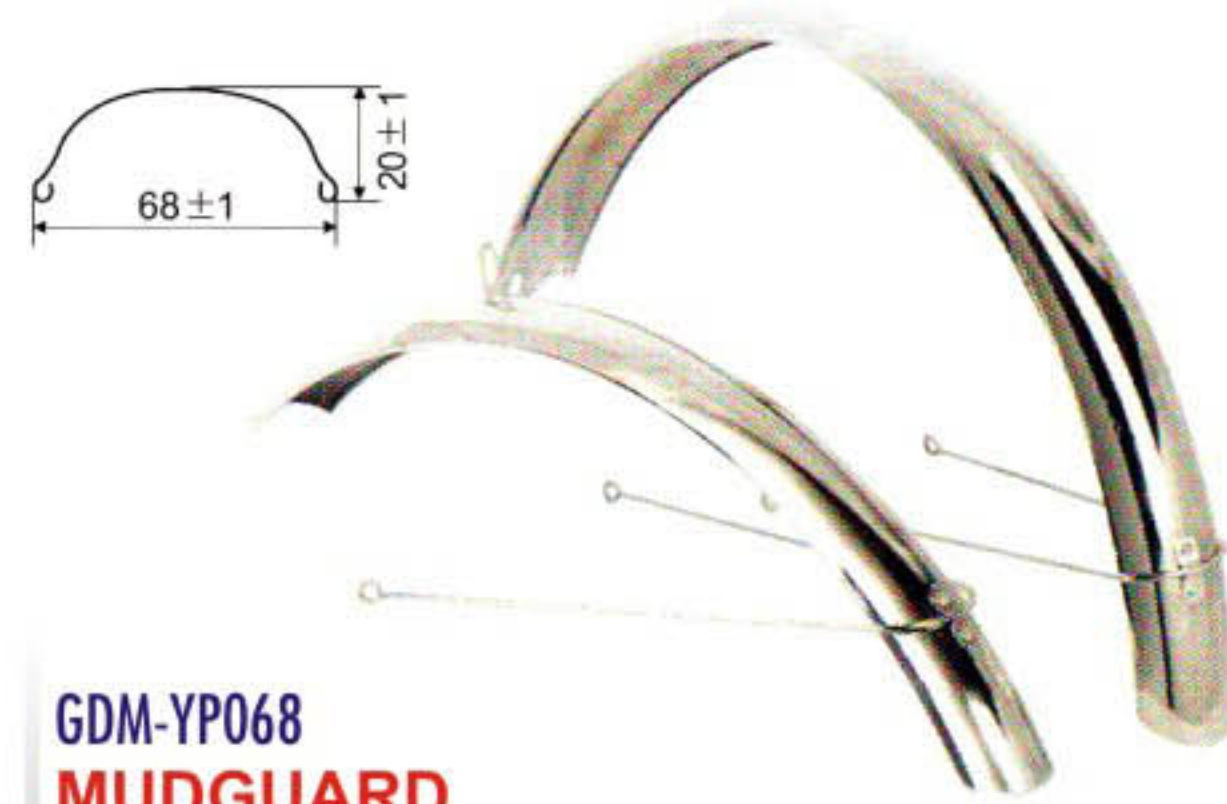

GDM-YP068
MUDGUARD
 Material : STEEL/STAINLESS/ALLOY
 Size : 2.125~2.35
 Packing :

STEEL BALLS



GIDE-AC-42



GIDE-AC-43



GJSLT 01
Bicycle Safety Light
 Tail Light
 Bulb : 9 Red LED,
 Function : Flash, Chasing, Steady, Off
 Battery : AAAx2(not Inclusive)



GJSLT 02
Bicycle Safety Light
 Tail Light
 Bulb : 5 Red LED with a board
 Function : Steady 6 flashing, off
 Battery : AAAx2(not Inclusive)



GJSLT 03
Bicycle Safety Light
 Tail Light
 Bulb : 3 Red LED
 Function : Flash steady, off
 Battery : AAAx2(not Inclusive)



GJSLT 06
Bicycle Turning Light
 Specifications : 8 Sound Horn,
 7 Super Bright LED,
 Night light
 Battery : AAAx2(not Inclusive)



GJSLT 07
Bicycle Horn
 Specifications : 8 Sound & 8 Flashing Horn
 with 5 LED
 Battery : AAAx2(not Inclusive)



GJSLT 10
Bicycle Horn
 Specifications : 8 Sound & 7 Flashing Horn
 Battery : AAAx2(not Inclusive)



GJSLT 12
Bicycle Front Light
 Specifications : 5 White LED, Chasing flash,
 Steady, Off.
 Battery : AAAx4(not Inclusive)



GJSLT 13
Bicycle Front Light
 Specifications : 4 white LED, On,Off
 with low battery indicator
 Battery : AAAx4(not Inclusive)



GJSLT 14
Dynamo Light
 Specifications : Plastic front light
 Aluminum body 6V/3W



GJSLT 15
Tyre Light
 Specifications : One LED in a pair
 (2 Red or 2 Blue)
 Battery : Ag 10x3(Blue)
 Ag10x2(red) inclusive



GJSLT 16
Cycle computer
 Specifications : 13 functions



GJSLT 17
Speedometer
 Specifications : Mechanical Operated

HELMET



GJSHL-01
HELMET
6 AIR VENTS PVS TOP SHELL
Size : L(54-56CM) M(52-54CM)
S(49-52CM)



GJSHL-02
HELMET
6 AIR VENTS PVS TOP SHELL
Size : L(54-56CM) M(52-54CM)
S(50-52CM)



GJSHL-03
HELMET
6 AIR VENTS PVS TOP SHELL
Size : L(55-58CM) M(53-55CM)
S(50-53CM)



GJSHL-04
HELMET
9 AIR VENTS PVS TOP SHELL
Size : L(55-57CM) M(53-55CM)
S(51-53CM)



GJSHL-05
HELMET
9 AIR VENTS PVS TOP SHELL
Size : L(57-59CM) M(55-57CM)
S(52-55CM)



GJSHL-06
HELMET
9 AIR VENTS PVS TOP SHELL
Size : L(55-58CM) M(53-55CM)
S(50-53CM)



GJSHL-07
HELMET
11 AIR VENTS PVS TOP SHELL
Size : L(58-60CM) M(56-58CM)
S(54-56CM)



GJSHL-08
HELMET
12 AIR VENTS PVS TOP SHELL
Size : L(58-60CM) M(56-58CM)
S(54-56CM)



GJSHL-09
HELMET
12 AIR VENTS PVS TOP SHELL
Size : L(55-55CM) M(52-54CM)
S(48-50CM)



GJSHL-10
HELMET
14 AIR VENTS PVS TOP SHELL
Size : L(52-54CM) M(50-52CM)
S(48-50CM)



GJSHL-11
HELMET
22 AIR VENTS PVS TOP SHELL
Size : 54-60CM



GJSHL-12
HELMET



BASKETS



GJSHT-001
BASKET
Material : STEEL
Size : 27X20X21CM,
Availacle : BLACK OR COLOURS



GJSHT-002
BASKET
Material : STEEL
Size : 35X26X26CM
Availacle : BLACK OR COLOURS



GJSHT-003
BASKET
Material : STEEL
Size : 35X26X26CM
Availacle : BLACK OR COLOURS



GJSHT-004
BASKET
Material : STEEL
Size : 34.5X26X26CM
Availacle : BLACK OR COLOURS



GJSHT-005
BASKET
Material : STEEL
Size : 37X25X26CM
Availacle : BLACK OR COLOURS



GJSHT-006
BASKET
Material : STEEL
Size : 36X23X22CM
Availacle : BLACK OR COLOURS

BRAKE SHOE



HUB STEPS



GHX-Y06-1-02
Alloy Hub Step
 25mmx75mm ,
 Available in Self and
 Anodised Red, Blue, Black , Pink & Yellow



GHX-Y06-1-03
Alloy Hub Step
 25mmx70mm
 Available in Self and
 Anodised Red, Blue, Black , Pink & Yellow



GHX-Y06-1-06
Alloy Hub Step
 Super small 20mmx75mm
 Available in Self and
 Anodised Red, Blue, Black , Pink & Yellow



GHX-Y06-1-09
Alloy Hub Step
 Big 38x110mm
 Available in Self and
 Anodised Red, Blue, Black , Pink & Yellow



GHX-Y06-1-10
Alloy Hub Step
 Big 38x110mm
 Available in Self and
 Anodised Red, Blue, Black , Pink & Yellow



GHX-Y06-1-15
Alloy Hub Step
 25mmx75mm ,
 Available in Self and
 Anodised Red, Blue, Black , Pink & Yellow

VALVE CAPS



GHX-1A-04



GHX-1A-05



GHX-1A-06



GHX-1A-10



GHX-1A-13



GHX-1A-33



GHX-1A-70

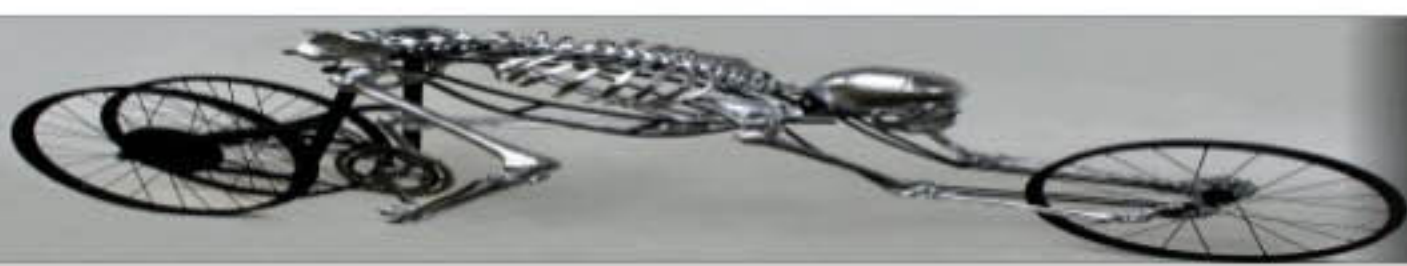

TYRES



GF-103

24X1.3/8 & 26X1.3/8
Nylon



GF-135

26x2.125 Black
Heavy Duty Nylon



GF-108

700x23C(23-622), 27X1.1/4(32-630)
Nylon



GF-136

26x2.125 Black
Heavy Duty Nylon



GF-112

12.1/2x2.1/4 , 16x1.95, 20x1.95, 24X1.95, 26X1.95, 16X2.1, 20X2.1,
24X2.1, 26X2.10, 16X2.125, 20X2.125, 24X2.125, 26X2.125
Nylon(Also available in coloured lines red, blue and yellow)



GF-138

26x2.125 Black Heavy Duty
FOR TRICICLO Nylon(Also available in coloured lines)



GF-125

12.1/2x2.1/4 , 16x1.95, 20x1.95, 24X1.95, 26X1.95, 16X2.1, 20X2.1,
24X2.1, 26X2.10, 16X2.125, 20X2.125, 24X2.125, 26X2.125
Nylon(Also available in coloured lines red, blue and yellow)



GF-114

16x2.125", 20x2.125 black
Nylon



TYRES



GLM-001

24X1.95, 26X1.95, 24X2.1, 26X2.10, 24X2.125, 26X2.125
Nylon (Also available in coloured lines red, blue and yellow)



GLM-041

26x2x1.1/2
Nylon



GLM-002

12.1/2x2.1/4, 16x1.95, 20x1.95, 24X1.95, 26X1.95, 16X2.1, 20X2.1, 24X2.1, 26X2.10, 16X2.125, 20X2.125, 24X2.125, 26X2.125,
Nylon (Also available in coloured lines red, blue and yellow)



GF-51

16x1.95, 20x1.95, 24X1.95, 26X1.95, 16X2.1, 20X2.1, 24X2.1, 26X2.10, 16X2.125, 20X2.125, 24X2.125,



GLM-003

20 x 2.125 Black
Nylon



GLM-016

24X1.3/8 & 26X1.3/8
Nylon



GLM-040

HEAVY DUTY FOR TRICICLO
26X2.125, 26X2.35 Nylon
(Also available with coloured lines, red, blue, white and yellow)



GRT-208

24X1.3/8 (37-540) , 24x1.75(47-507), 26x1.75(47-559) 26X1.3/8 (37-590)
Nylon



GSHB-A01
STEEL HUB THIN TYPE
Spoke holes and dia as per order.
Finish : CP or ED



GSHB-A03
STEEL HUB PARALAX TYPE
Spoke holes and dia as per order.
Finish : CP or ED



GSHB-A05
STEEL HUB OVAL TYPE
Spoke holes and dia as per order.
Finish : CP or ED



Registered Office :
GURSAM INTERNATIONAL

Lane No. 7 and 8, Suraj Nagar, New Shimla Puri, Ludhiana - 141003 (Punjab) INDIA
Phone : +91 - 161 - 2503091 / 2506546 Fax : + 91 - 161 - 2496072
E-mail : gursamintl@sify.com Website : www.gursam.com

Branch Office :
GURSAM INTERNATIONAL

New Sunder Nagar, (Opp Medi City) Ferozpur Road, Ludhiana (Punjab) INDIA
Phone : + 91 - 161 - 5019546

Sister Concerns :
VEER BROTHERS INDUSTRIAL CORPORATION

Ludhiana (Punjab) INDIA

WORM MAGIC BIOTEC

V.P.O Rajewal Tehsil : Samrala Ludhiana (Punjab) INDIA
E-mail : info@wormmagic.in Website : www.wormmagic.in